

Operating Instructions

LCD Projector

Model No. **PT-L795U**



Panasonic[®]

Read these instructions completely before operating this unit.

TQBJ 0011

Dear Panasonic Customer:

This instruction booklet provides all the necessary operating information that you might require. We hope it will help you to get the most performance out of your new product, and that you will be pleased with your Panasonic LCD projector.

The serial number of your product may be found on its back. You should note it in the space provided below and retain this booklet in case service is required.

Model number: **PT-L795U**

Serial number: _____

Contents

Features	1	About dot clock adjustment	31
IMPORTANT SAFETY NOTICE	2	Using other useful functions	32
Precautions with regard to safety	3	System configuration example	38
Warning when using 220-240 V power supplies	4	About the Macintosh adapter	40
Precautions on handling	5	Wireless mouse	40
Location and function of each part	6	Using the serial connector	41
Before using the remote control unit	9	Indicators	43
Menu operation guide	11	Cleaning the air filter	44
Turning the power on and off	13	Lamp unit replacement period	46
Screen requirements	14	Replacing the lamp unit	46
Standard setting-up positions	15	Before asking for service	49
Adjusting the lens	18	Specifications	50
Setting-up positions and changing the projection method	19	Trademark acknowledgements	51
Basic operation	20	Dimensions	52
Selecting the picture mode	24	NOTES IMPORTANTES CONCERNANT LA SÉCURITÉ	53
Adjusting the picture to the desired setting	25	Précautions concernant la sécurité	54
Adjusting the white balance	26	Avertissement pour l'utilisation	
Adjusting the sound to the desired setting	27	d'une alimentation de 220-240 V	55
Correcting the picture position automatically	28	Précautions à suivre lors de la manipulation	56
Adjusting the picture position	29	Période de remplacement de la lampe	57
Adjusting the video size	30	Remplacement de l'unité de lampe	57

Features

High luminance, high-density and high-quality pictures

A new 1.3-inch (diagonal) polysilicon LCD panel and a 280-W metal halide lamp have been adopted. In addition, a newly-developed optical system enables the projector to produce a high luminance of 650 ANSI lumens while providing high density and high picture quality at XGA (1024 × 768) resolution.

Screens from 30 inches to 300 inches can be used

The projector can be positioned so as to project onto screens ranging in diagonal size from 30 inches to 300 inches. A projection method switching function (for switching between front and rear projection), a lens position adjustment function (for light axis shifts) and an electronic zoom/focus lens allow pictures to be projected from a variety of different positions.

Lightweight and compact, and setting-up is easy

The light and compact body weighs approximately 22.0 lbs. (10.0 kg), and a carrying handle and a retractable lens function are also provided, so that the projector can be transported easily. The projector can also be set up easily, without the need for complex setting-up adjustments.

Equipped with a variety of convenient functions

A variety of functions such as the following have been provided.

- A blue background is projected when no signal is being input, so that the screen is not illuminated.
- Muting functions for video and audio signals and the input signal display function can be toggled on and off.
- A countdown timer function is provided.
- A retractable lens function is provided.
- The projector automatically switches to standby mode if no signal is input for a continuous period.
- The function of the POWER button on the remote control unit can be disabled.
- The language of on-screen displays can be changed.
- Compatible with Windows 95 Plug-And-Play (DCC1, DCC2B)

IMPORTANT SAFETY NOTICE

WARNING: To prevent damage which may result in fire or shock hazard, do not expose this appliance to rain or moisture.

Power Supply: This LCD Projector is designed to operate on 100–120 volts and 220–240 volts, 50/60 Hz AC, house current only.



The lightning flash with arrowhead symbol, within an equilateral triangle, is intended to alert the user to the presence of uninsulated “dangerous voltage” within the product’s enclosure that may be of sufficient magnitude to constitute a risk of electric shock to persons.



The exclamation point within an equilateral triangle is intended to alert the user to the presence of important operating and maintenance (servicing) instructions in the literature accompanying the product.

CAUTION: This equipment is equipped with a three-pin grounding-type power plug. Do not remove the grounding pin on the power plug. This plug will only fit a grounding-type power outlet. This is a safety feature. If you are unable to insert the plug into the outlet, contact an electrician. Do not defeat the purpose of the grounding plug.

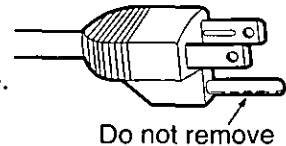

WARNING: This equipment has been tested and found to comply with the limits for a Class A digital device, pursuant to Part 15 of the FCC Rules. These limits are designed to provide reasonable protection against harmful interference when the equipment is operated in a commercial environment. This equipment generates, uses, and can radiate radio frequency energy and, if not installed and used in accordance with the instruction manual, may cause harmful interference to radio communications. Operation of this equipment in a residential area is likely to cause harmful interference in which case the user will be required to correct the interference at his own expense.

CAUTION: Any unauthorized changes or modifications to this equipment would void the users authority to operate.

Precautions with regard to safety

WARNING

Setting-up

Do not install this projector in a place which is not strong enough to take the projector's full weight.

- If the installation location is not strong enough, the projector may fall down, which could cause severe injury and/or damage.

Ask a qualified technician to carry out installation work such as installing the projector in the ceiling.

- If installation is not carried out correctly, it can cause injury or electric shocks to occur.

When using the projector

Do not place the projector on top of surfaces which are sloped or unstable.

- The projector may fall down or tip over.

Do not place any objects on top of the projector.

- If water spills onto the projector or foreign objects get inside it, a short-circuit may occur which could result in fire or electric shocks. If any foreign objects get inside the projector, please consult an Authorized Service Center.

Do not cover the air filter and the air outlet.

- Doing so may cause the projector to overheat, which can cause fire or damage to the projector.

Do not stick any foreign objects into the projector.

- Do not insert any metal objects or flammable objects into the ventilation holes or drop them onto the projector, as doing so can cause fire or electric shocks to occur.

Do not remove the cover or modify it in any way.

- High voltages which can cause severe electric shocks are present inside the projector. For any inspection, adjustment and repair work, please contact an Authorized Service Center.

Do not spill water on the projector.

- This can cause fire or electric shocks to occur.

Securely insert the power cord plug as far as it will go.

- If the plug is not fully inserted, heat may be generated which could cause fire. If the plug is damaged or the wall socket plate is loose, they should not be used.

Do not handle the power cord plug with wet hands.

- Doing so may cause electric shocks to occur.

Do not do anything that might damage the power cable.

- Do not damage the cable, make any modifications to it, place heavy objects on top of it, heat it, place it near any hot objects, twist it, bend it excessively or pull it. To do so may cause fires and electric shocks to occur. If the power cable becomes damaged, have it repaired at an Authorized Service Center.

Clean the power cable regularly to prevent it from becoming covered in dust.

- If dust builds up on the power cord plug, the resultant humidity can damage the insulation, which could result in fire. Pull the power cord out from the wall outlet and wipe it with a dry cloth.
- If not using the projector for an extended period of time, pull the power cord plug out from the wall outlet.

If problems occur during use

If a problem occurs (such as no picture or no sound), or if smoke or an abnormal odor starts to come out from the projector, immediately pull the power cord plug out from the wall outlet.

- If you continue to use the projector in this condition, fire or electric shocks could result. After checking that the smoke has stopped coming out, contact an Authorized Service Center so that the necessary repairs can be made. Repairing the projector yourself is extremely dangerous, and it should never be done.

If water or foreign objects get inside the projector, if the projector is dropped, or if the cabinet becomes damaged, disconnect the power cord plug immediately.

- A short may occur, which could cause fire. Contact an Authorized Service Center for any repairs that need to be made.

CAUTION

When using the projector

Do not use the projector in places which are subject to humidity, dust, oil fumes or steam.

- Fire or electric shocks could result.

Do not place any heavy objects on top of the projector.

- Doing so can cause the projector to become unbalanced and fall, which could result in damage and/or injury.

Do not look into the lens while the projector is being used.

- Strong light is emitted from the projector's lens. If you look directly into this light, it can hurt and damage your eyes.

Do not bring your hands or other objects close to the air outlet port.

- Heated air comes out of the air outlet port. Do not bring your hands or face, or objects which cannot withstand heat close to this port, otherwise burns or deformation could result.

When disconnecting the power cable, hold the plug, not the cable.

- If the power cable itself is pulled, the cable will become damaged, resulting in the possibility of fire or serious electric shocks.

Be sure to disconnect all cables before moving the projector.

- If the projector is moved while some of the cables are still connected, the cables may become damaged, and fire or electrical shocks could result.

Cleaning and maintenance

Take particular care when replacing the lamp unit.

- The metal halide lamp contains gas under high pressure. If it is dropped or hit against other objects, it may break, which could cause injury or problems with operation.

Ask an Authorized Service Center to clean inside the projector at least once a year.

- If dust is left to build up inside the projector without being cleaned out, it can cause fire or problems with operation to occur. Ask your nearest Authorized Service Center to clean the projector when required. Consult your Authorized Service Center for details regarding cleaning costs.

Disconnect the power plug from the wall outlet as a safety precaution before carrying out any cleaning.

- Electric shocks can result if this is not done.

Warning when using 220–240 V power supplies

When using this projector with a 220–240 V power supply, you must replace the power cord and the fuse. Use a power cord and fuse which corresponds to the specifications given at right. If this is not done, fire or malfunctions may result.

Power cord	250 V AC, 10 A
Fuse	250 V AC, T4 A, 5.2 mm dia., 20 mm length

Replace the fuse by the following procedure.

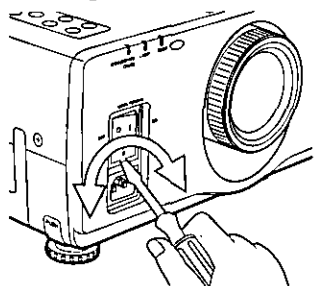
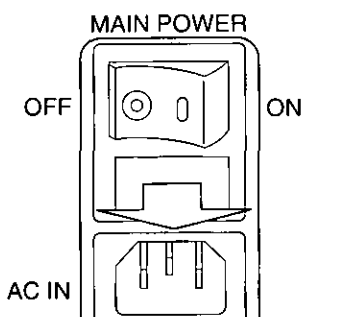
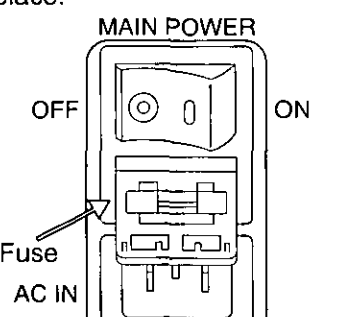
<p>① Insert a flat-tipped screwdriver with a narrow head into the hole below the fuse holder, and turn the screwdriver 2 - 3 times to the left and right.</p> 	<p>② After the fuse holder has moved forward slightly, pull it out toward you.</p> 	<p>③ Replace the fuse with a 250 V AC, T4 A fuse, and then push the fuse holder securely back into place.</p> 
---	--	---

Precautions on handling

Cautions regarding setting-up

Observe the following at all times when setting up the projector.

- Avoid setting up in places which are subject to vibration or shocks.
If the projector is set up in locations with strong vibration, such as near a motor, or if it is installed inside a vehicle or on board a ship, the projector may be subjected to vibration or shocks which can damage the internal parts and cause malfunctions or accidents. Accordingly, set up the projector in a place which is free from such vibrations and shocks.
- Do not set up the projector near high-voltage power lines or near motors.
The projector may be subject to electromagnetic interference if it is set up near high-voltage power lines or motors.
- Do not set up the projector directly on top of plastic sheet or carpet.
Plastic sheets can stick to the air filter, which can cause the inside of the projector to overheat and the power supply to switch off.
- If installing the projector to the ceiling, ask a qualified technician to carry out all installation work.
If the projector is to be suspended from the ceiling, you will need to purchase the separate installation kit (Model No.: ET-PK592). Furthermore, all installation work should only be carried out by a qualified technician.

Notes on use

- In order to get the best picture quality
If outside light or light from indoor lamps is shining onto the screen, the images projected will not have good contrast. Draw curtains or blinds over any windows, turn off any fluorescent lights near the screen and cover any highly-reflective floor and wall surfaces with carpet or wallpaper to prevent reflection.
- Do not touch the surfaces of the lens with your bare hands.
If the surfaces of the lens becomes dirty from fingerprints or anything else, this will be magnified and projected onto the screen. Moreover, when not using the projector, retract the lens and then cover it with the accessory lens cap.
- About the screen
If the screen you are using is dirty, damaged or discolored, attractive projections cannot be obtained. Do not apply any volatile substances to the screen, and do not let it become dirty or damaged.

Before carrying out cleaning and maintenance, be sure to disconnect the power cord plug from the wall outlet.

Wipe the cabinet with a soft, dry cloth.

If the cabinet is particularly dirty, soak the cloth in water with a small amount of neutral detergent in it, squeeze the cloth very well, and then wipe the cabinet. After cleaning, wipe the cabinet dry with a dry cloth. If using a chemically-treated cloth, read the instructions supplied with the cloth before use.

Do not wipe the lenses with a cloth that is dusty or which produces lint.

If any dust or lint gets onto the lenses, such dust or lint will be magnified and projected onto the screen. Use the blower to clean any dust and lint from the lens surfaces, or use a chamois cloth to wipe off any dust or lint.

About condensation

Droplets of water form on the windows which are warmed suddenly in winter, and on the outside of beer bottles which are taken out of a fridge in summer.

This phenomenon is called condensation; if condensation should occur on the surfaces of the projection lenses or mirror inside the projector, the picture may become fuzzy or it may not be visible at all.

If there is high humidity, or if the projector is suddenly brought from a cold environment into a warm one, the projector will normally stop projecting. In such cases, the projector will normally resume projection as it becomes conditioned to the ambient temperature.

Location and function of each part

Remote control unit

<Front view>

LIGHT button (page 10)

This button is used to illuminate the remote control unit buttons.

ENTER button

This button is used to accept and to activate items selected in the on-screen menu screens.

Arrow (▲, ▼, ◀ and ▶) buttons

These buttons are used to select and adjust items in the on-screen menu screens.

MENU button

This button is used to display and clear the MENU screen and to return to a previously-displayed screen.

MUTE button (pages 24 and 37)

This button is used to momentarily cancel the output of sound from the speakers. The functioning of this button can be changed so that it can be used to cancel both sound and picture simultaneously.

POWER button (page 13)

This button is used to turn the projector power supply on and off.

FREEZE button (page 23)

This button is used to momentarily freeze projection so that a still picture is displayed.

STD (standard) button (pages 23 and 33)

This button is used to return all picture adjustment values to the standard setting values which were made at the time of shipment from the factory.

When the POINT ZOOM function is being used, this button functions to switch the enlargement ratio.

VOL +/- buttons (page 23)

These buttons are used to adjust the volume of sound coming from the built-in speakers or to adjust the sound level of the signal being output from the AUDIO OUT terminal.

RGB button (page 20)

This button is used to switch the selected input source between RGB 1 and RGB 2.

VIDEO button (page 20)

This button is used to switch the selected input source between VIDEO and S-VIDEO.

Pointer button (page 40)

When the projector is connected to a personal computer by means of the accessory or optional mouse cable, this button can be used to move the cursor in place of the computer's mouse.

CLICK 2 button (page 40)

When the projector is connected to a personal computer by means of the accessory or optional mouse cable, this button operates in the same way as the right button on a standard mouse with two buttons.

<Side view>

Transmitter (page 10)

The remote control signals are transmitted from both the front and the sides. Face this section toward the remote control signal receptor of the projector to operate the projector.

Click 1 button (page 40)

This button corresponds to the button on a single-button mouse, or to the left button on a standard mouse with two buttons.

Battery compartment cover (page 9)

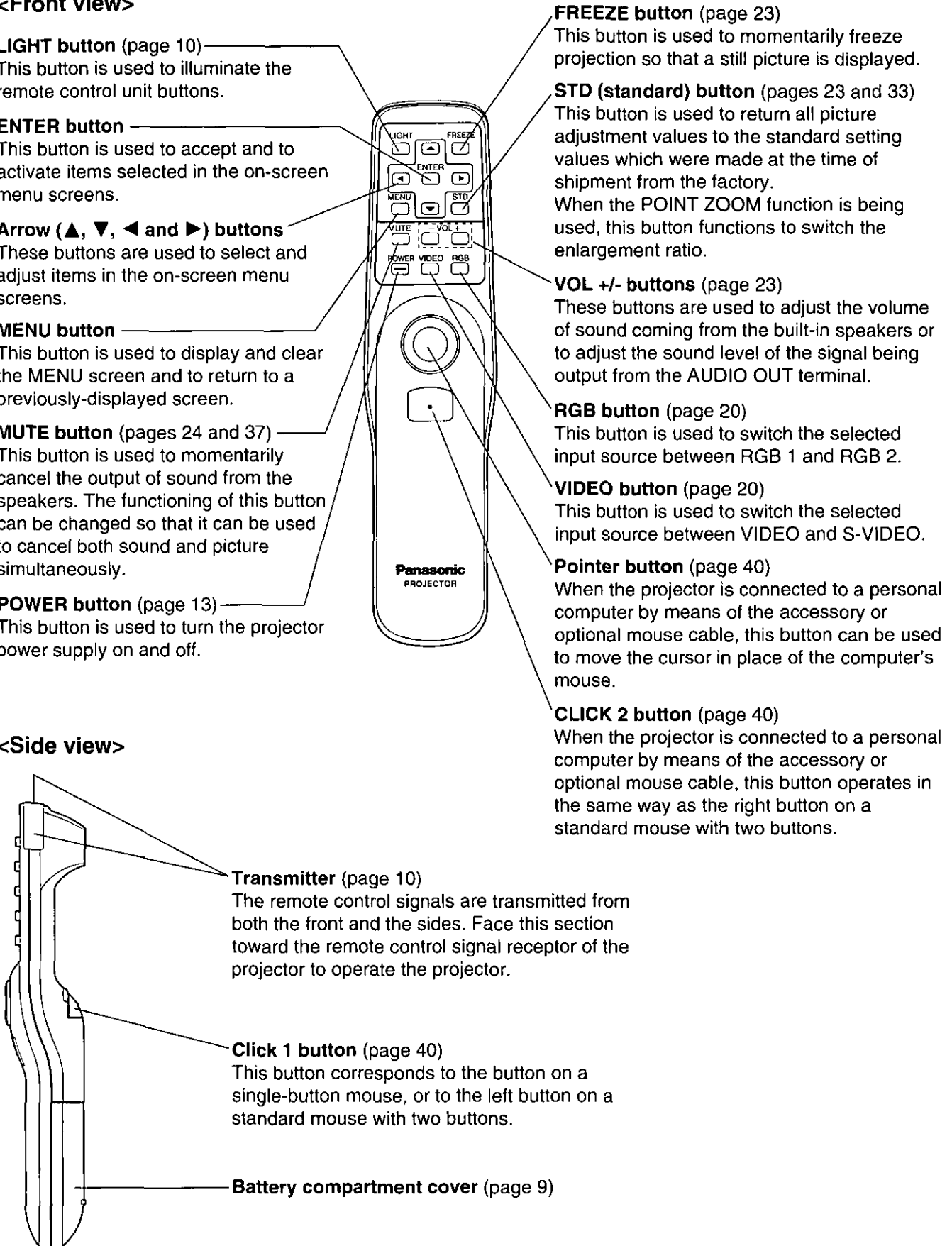

Projector

<Top and front>

RGB button (page 20)

This button is used to switch the selected input source between RGB 1 and RGB 2.

VIDEO button (page 20)

This button is used to switch the selected input source between VIDEO and S-VIDEO.

POWER button (page 13)

This button is used to turn projection of the picture on and off.

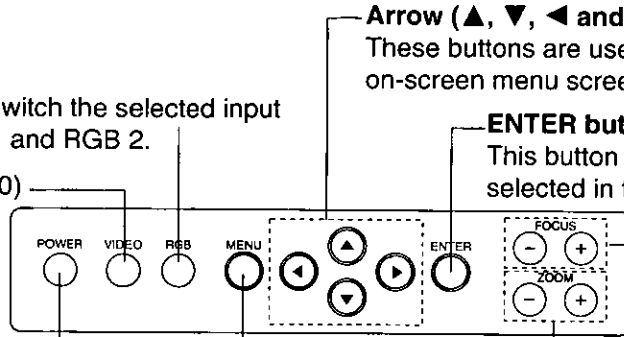

Arrow (▲, ▼, ◀ and ▶) buttons

These buttons are used to select and adjust items in the on-screen menu screens.

ENTER button

This button is used to accept and to activate items selected in the on-screen menu screens.

FOCUS adjustment +/- buttons (page 18)

These buttons are used to adjust the picture focus.

ZOOM adjustment +/- buttons (page 18)

These buttons are used to adjust the picture size.

Built-in speakers (page 23)

These are built-in speakers which are capable of outputting stereo sound.

Carrying handle

Pull out the handle and hold it when transporting the projector.

LENS SHIFT dial (page 16)

Turning this dial moves the lens up and down. Use it to make fine adjustments to the lens position when setting up the projector.

Remote control signal receptor (page 10)

This receives the infrared signal transmissions from the remote control unit.

Focus ring (page 18)

This ring is used to adjust the image focus.

Air outlet port

Projection lens

This lens enlarges the image and projects it onto the screen.

Lens cap

MAIN POWER switch (page 13)

This switch turns the power supply to the projector on and off.

Fuse holder (page 4)

Power input socket (AC IN)

The power cord which is supplied with the projector is connected here.

TEMP indicator (page 43)

This indicator illuminates or flashes as a warning if the temperature inside the projector reaches an abnormal level.

LAMP indicator (page 43)

This indicator illuminates when the useful life of the lamp is coming to an end, and it flashes when there is a problem with the lamp unit.

Power indicator (page 13)

This indicator becomes red when the MAIN POWER switch is turned to ON. It changes to green when the power is turned on. When this indicator is orange, it indicates that the power has been turned off but the cooling fan is still operating (for approximately 90 seconds), or that the power saving function has activated and the light source lamps have been switched off.

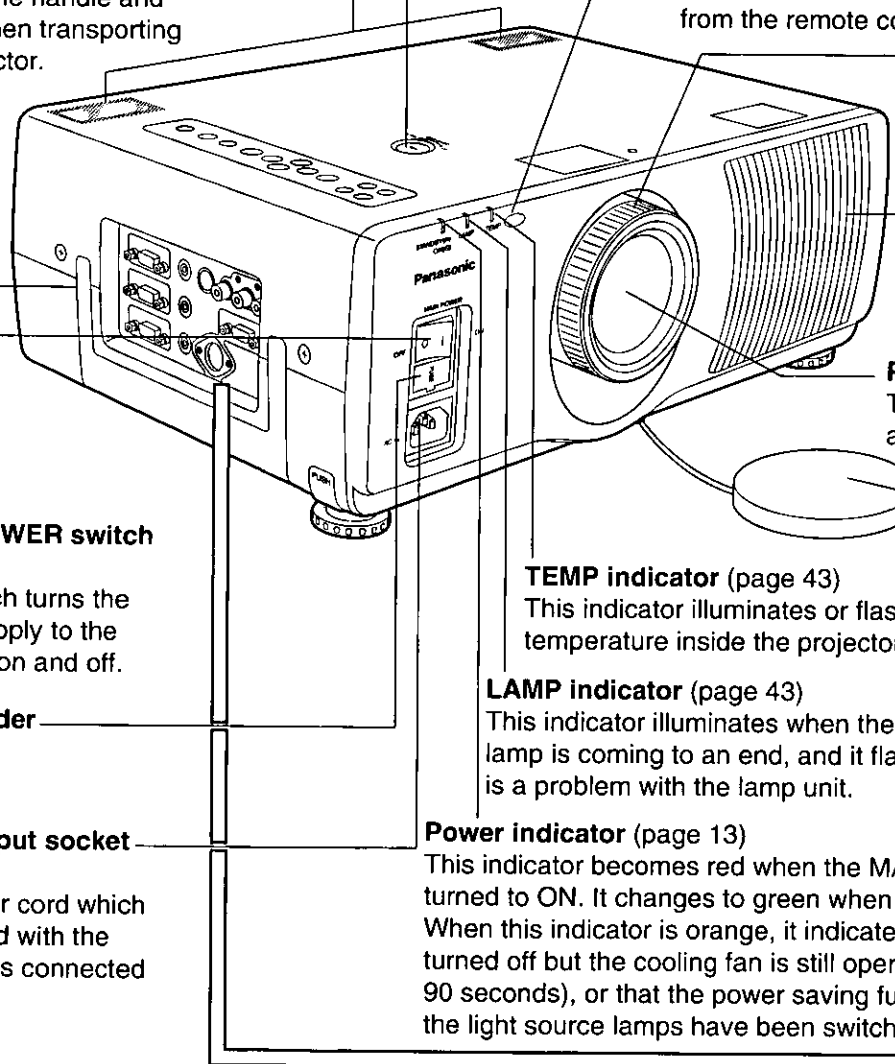

<Back, bottom and right view>

Lamp unit cover (page 47)
Remove this cover to get access to the lamp unit.

Fixing screw for the lamp unit cover (page 47)
Remove this screw when replacing the lamp unit.

Adjuster button (page 17)
This button is used to unlock the adjustable legs.

Adjustable legs (two) (page 17)
These legs can be used to adjust the angle of inclination of the projector.

Remote control signal receptor (page 10)
This receives the infrared signal transmissions from the remote control unit.

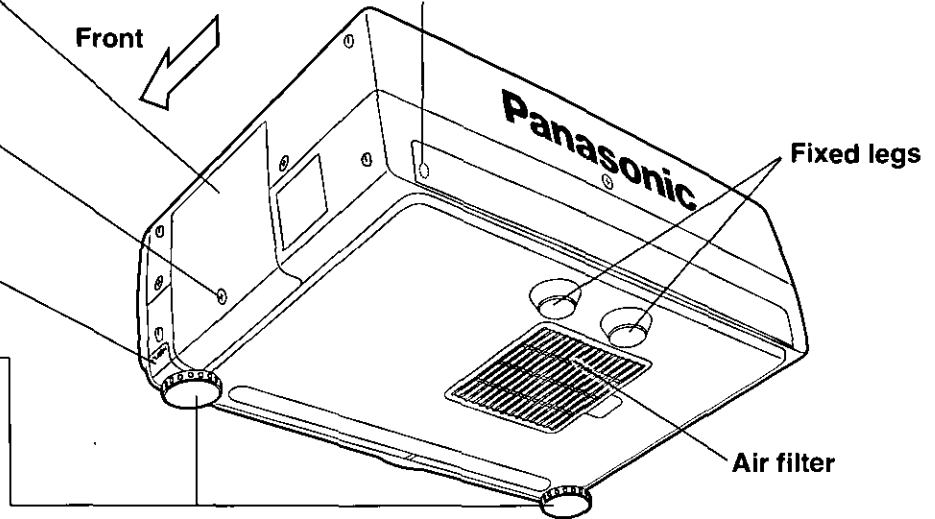

<Side terminal board>

AUDIO OUT terminal (pages 38 and 39)
This terminal is used to output the audio signals from the source which is connected to the AUDIO IN terminals for RGB or video signals.
The signal which is output corresponds to the source which has been selected by pressing either the VIDEO or RGB button. The output level for this signal can be adjusted by using the VOL +/- buttons.
If audio equipment is connected to this terminal, no sound will be output from the built-in speakers.

RGB OUT connector (page 39)
This connector is used to output the RGB signals from the source which is connected to the RGB 1 or RGB 2 connector.
The signal which is output corresponds to the source which has been selected by pressing the RGB button.

RGB 2 (RGB IN/AUDIO IN) connector/terminal (page 39)
This connector and terminal are used to input RGB signals and the audio signal which accompany them.

RGB 1 (RGB IN/AUDIO IN) connector /terminal (page 39)
This connector and terminal are used to input RGB signals and the audio signal which accompany them.

S-VIDEO IN terminal (page 38)
This terminal is used to input S-VIDEO signals.

VIDEO IN terminal (page 38)
This terminal is used to input composite video signals.

AUDIO IN (L-R) terminals for S-VIDEO/VIDEO input (page 38)
These terminals are used to input audio signals which correspond to the signals input to the VIDEO IN or S-VIDEO IN terminal.

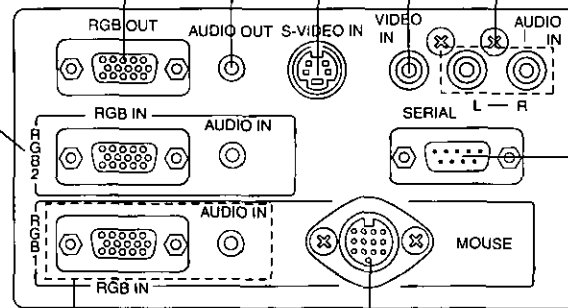

SERIAL connector (page 41)
This connector is used to connect a personal computer to the projector in order to externally control the projector.

MOUSE connector (pages 39 and 40)
This connector is used to connect an accessory or separate mouse cable. This lets you operate a personal computer using the pointer button and click buttons on the remote control unit instead of using a mouse.

Before using the remote control unit

Inserting the batteries

Insert the AA batteries supplied with the remote control unit making sure that the polarities are correct.

Open the battery compartment cover.

Push the section with the ▽ mark down firmly, and then pull the cover toward you to remove it.

Insert the batteries.

Insert the batteries so that their direction matches the polarity markings inside the compartment.

NOTE:

- Do not use rechargeable (Ni-Cd) batteries.

Close the battery compartment cover.

Return the battery compartment cover to its original position.

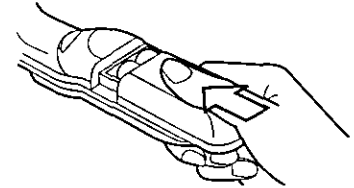
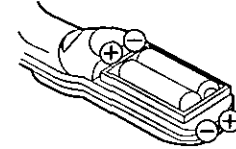
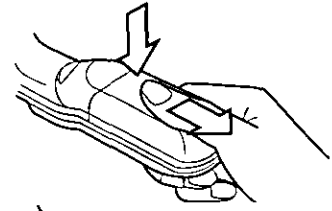

Notes on using the batteries

The following should be observed in order to prevent damage to or leaking of the batteries.

Old Batteries

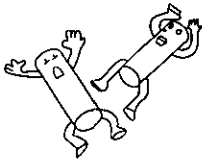

New Batteries



Replace both batteries at the same time. Furthermore, do not burn spent batteries or put them in with combustible garbage.

Do not mix old and new batteries or batteries of different types (such as alkali and manganese batteries).

DO NOT do any of the following:

NG

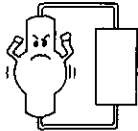

Do not recharge

NG

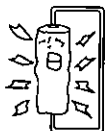

Do not short-circuit

NG



Do not open

NG



Do not heat or burn

Operating range of the remote control unit

Point the remote control unit toward the remote control signal receptor on the front or the rear of the projector to operate the projector. Refer to the illustration below for the operating range of the remote control unit.

<Top view>

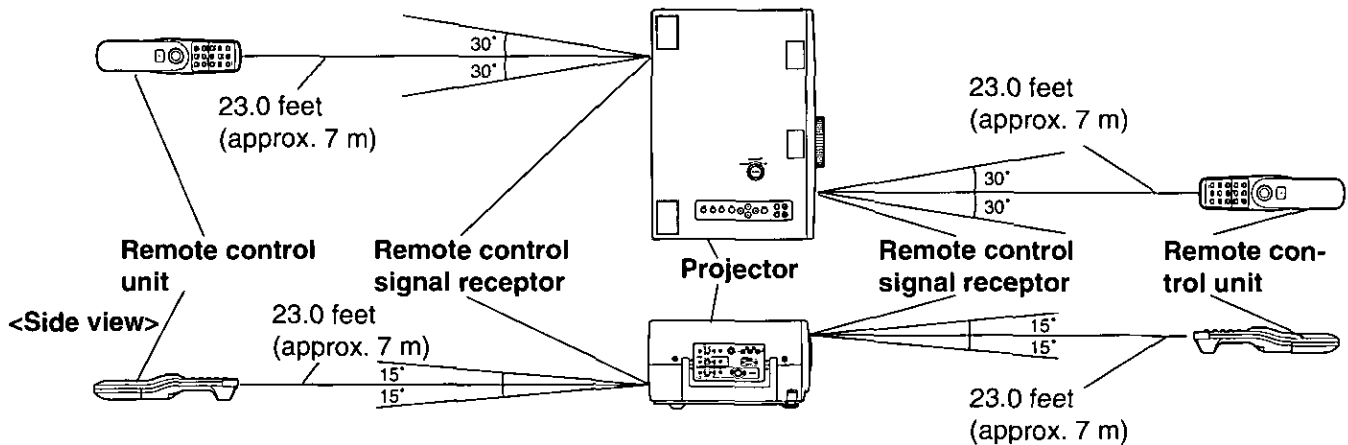

NOTE:

- The operating distance is within 23.0 feet (approximately 7 meters) from directly in front of the front or rear remote control signal receptors. Furthermore, if using the rear 60° (left and right) function to transmit the remote control signals, the operating distance is also 23.0 feet (7 meters).
- If strong light is allowed to shine onto the remote control signal receptor, or if there are any obstacles between the remote control signal receptor and the remote control unit, correct remote control operation may not be possible.

If facing the remote control unit toward the screen

The projector can also be operated by pointing the remote control unit toward the screen as shown in the illustration below.

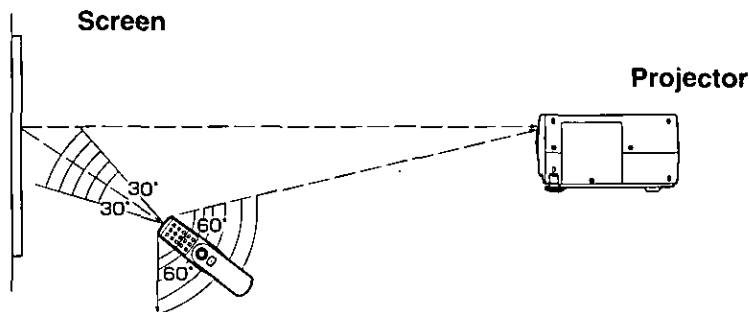

NOTE:

Remote control unit

- If facing the remote control unit toward the screen to operate the projector, the operating range of the remote control unit will be limited by the amount of light reflection loss caused by the characteristics of the screen used.
- The transmit function of the remote control unit can transmit within a range of 60° in the forward direction and 60° in the backward direction (60° on both left and right sides), assuming a method of use such as that shown above.

Illuminating the remote control unit buttons

If the LIGHT button on the remote control unit is pressed, the buttons on the remote control unit are illuminated for approximately 10 seconds.

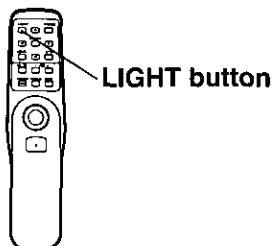

NOTE:

- If the LIGHT button is pressed once more while the remote control unit buttons are illuminated, the illumination period will be extended for a further 10 seconds.
- If any other buttons are pressed while the buttons are illuminated, the illumination will switch off, and will switch back on again for a further 10 seconds once the button which was pressed is then released.

Menu operation guide

This section explains how to reach the desired selection or setting screens from the MENU screen. Refer to the page indicated for further details on each screen item.

- (1) Press the MENU button.
- (2) Use the arrow (▲, ▼, ◀ and ▶) buttons to select an item, and then press the ENTER button.

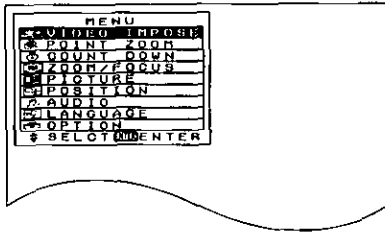

VIDEO IMPOSE
(Refer to page 32.)
Used to display a video signal image in a sub-screen on an RGB image.

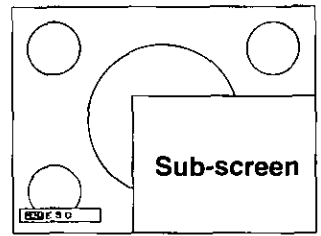

POINT ZOOM
(Refer to page 33.)
Used to enlarge and project a specific section of the input picture image.

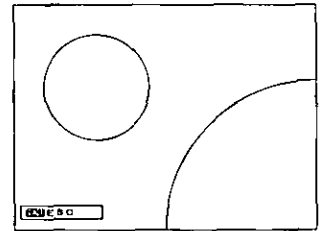

COUNT DOWN
(Refer to page 35.)
Used to set and activate the countdown timer.

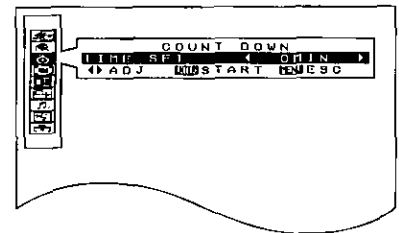

ZOOM/FOCUS
(Refer to page 18.)
Used to adjust the picture size and focus.

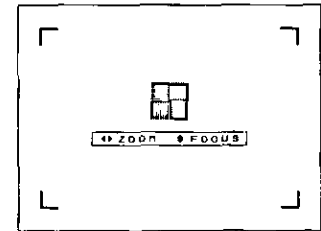

PICTURE(Refer to pages 22, 24-26.)
Used to carry out picture adjustments and to switch the signal format.

When an RGB signal is being projected

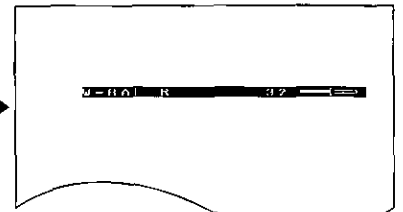
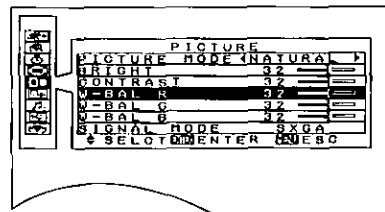

When a VIDEO/S-VIDEO signal is being projected

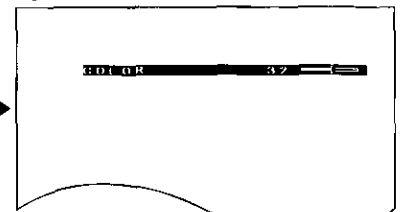
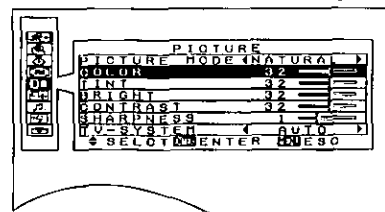

(1) Press the MENU button.

(2) Use the arrow (▲, ▼, ◀ and ▶) buttons to select an item, and then press the ENTER button.

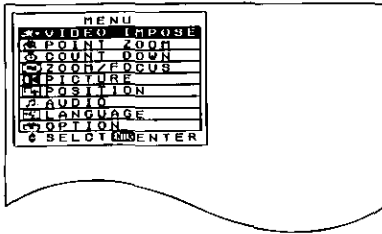

POSITION

(Refer to pages 28-32.)
Used to adjust the horizontal and vertical position of the picture and to adjust other properties such as the size.

When an RGB signal is being projected

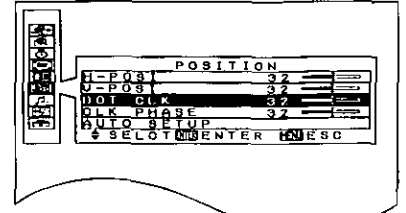

When a VIDEO/S-VIDEO signal is being projected

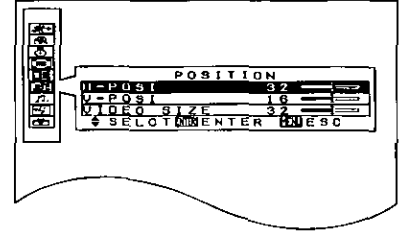

AUDIO

(Refer to page 27.)
Used to adjust the volume and left/right balance for the sound being output from the built-in speakers.

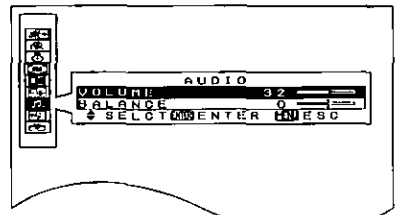

LANGUAGE

(Refer to page 35.)
Used to switch the on-screen display language.

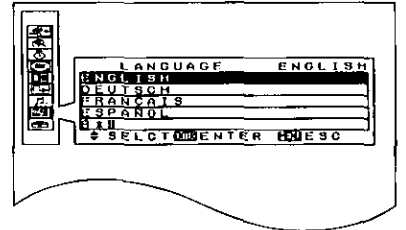

OPTIONS

(Refer to pages 19, 34, 36, 37 and 48.)
Used for detailed setting of useful functions.

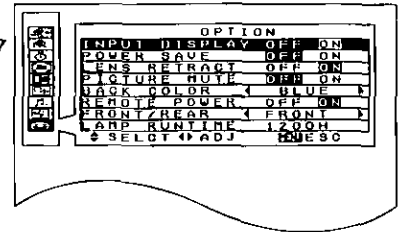

- The projector is provided with a function for switching the on-screen display language, but the explanations given in this Instruction Manual assume that the display language has been set to English.
- Each on-screen menu screen includes a display showing which buttons can be pressed.
- If “◀ ▶” is displayed next to an item in a menu screen, it indicates that the setting for this item can be changed using the “◀” and “▶” buttons.

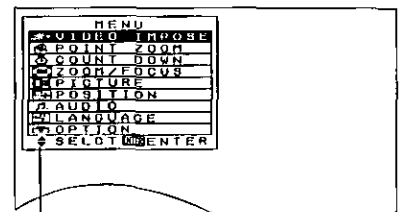

Operable button display

Turning the power on and off

If the MAIN POWER switch on the projector is pressed while the cooling fan is still operating, the operating life of the projector lamp will be shortened. Be sure to follow the procedures given below when turning the projector power supply on and off.

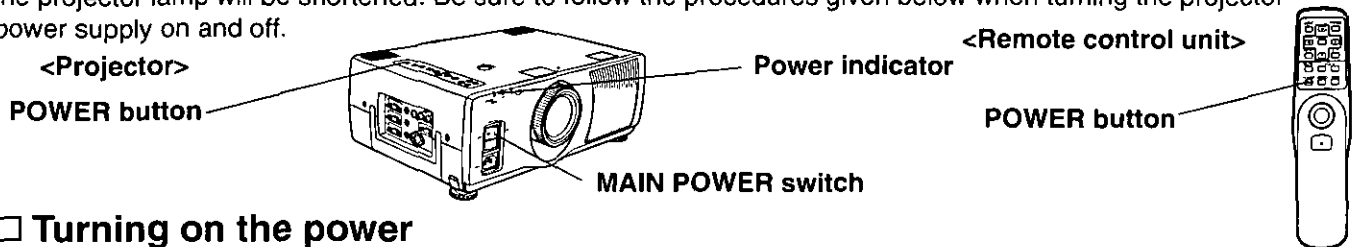

□ Turning on the power

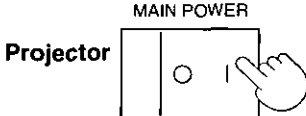
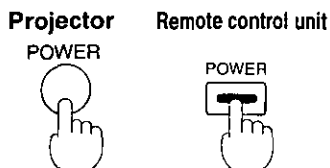
<p>1. Press the MAIN POWER switch.</p> 	<p>Press the MAIN POWER switch on the projector to the ON position.</p> <p style="text-align: center;">↓</p> <p>The power indicator will illuminate red and the projector will switch to standby mode.</p>
<p>2. Press the POWER button.</p> 	<p>Press the POWER button on either the top of the projector or on the remote control unit.</p> <p>The power indicator will alternate between green and orange. ↓</p> <p>The power indicator will illuminate green and a picture will be projected onto the screen after about 20 seconds.</p>

□ Turning off the power

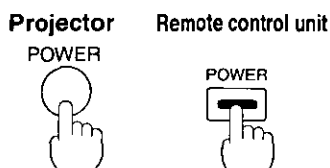
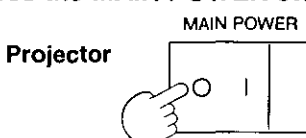
<p>1. Press the POWER button.</p> 	<p>Press the POWER button on either the top of the projector or on the remote control unit.</p> <p style="text-align: center;">↓</p> <p>The power indicator will illuminate orange and the projector will switch to standby mode.</p>
<p>2. Wait for the cooling fan to stop.</p>	<p>Wait for a while (approximately 90 seconds) until the cooling fan stops operating. (When the fan stops, the power indicator will illuminate red.)</p>
<p>3. Press the MAIN POWER switch.</p> 	<p>Press the MAIN POWER switch on the projector to the OFF position.</p> <p style="text-align: center;">↓</p> <p>The power indicator will switch off and the power supply will be turned off.</p>

NOTE:

- If the power is turned off using the POWER button, the cooling fan will continue to operate (for approximately 90 seconds) while the inside of the projector is still at a high temperature. Do not turn the MAIN POWER switch to the OFF position, disconnect the power cord plug from the wall socket or shut off the mains power supply until the cooling fan stops operating.
- If not using the projector for long periods of time, turn the MAIN POWER switch at the front of the projector to the OFF position.
- If the POWER switch is accidentally turned off while the projector is being used, wait a while for the lamp to cool down before turning the power back on again. If you turn the power back on immediately, it will shorten the operating life of the lamp.
- The REMOTE POWER function may cause the operation of the POWER button on the remote control unit to be disabled temporarily. For details about this function, refer to page 34.
- If the MAIN POWER switch has not been turned off, the projector will still draw approximately 7 W (at 100-120 V) / 13W (at 220-240 V) of power, even when the POWER button has been turned off and the fan has stopped.
- There may be cases where the lamp does not turn on straight away. In such cases, the projector will try to turn the lamp on again after 30 seconds have passed. (During this time, the power indicator will alternately flash green and orange.)
- The projector is equipped with a lens retracting function which will cause the lens to be retracted automatically when the power is turned off. However, the lens will not then return to the previously adjusted position even if the power is turned back on again. If you do not wish this function to operate, turn the function setting off while referring to "Using the lens retracting function" on page 36.
- A tinkling sound may be heard while the power indicator is turned off, but this is not a sign of a malfunction.

Screen requirements

This projector is used to project the image onto flat screens. However, the brightness and viewable range will vary depending on which type of screen is used.

When selecting a screen, check the characteristics of the screen to ensure that it is suitable for the intended place of use.

Screen characteristics (reference)

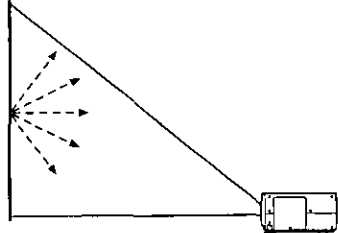
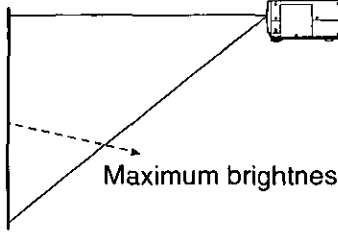
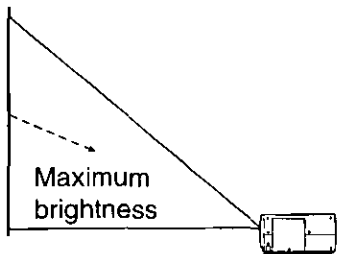
Screen type		Screen characteristics
Reflective screens	White screen	<p>This type of screen can be seen from anywhere, so there are no limits on the viewing position. However, the surrounding walls should be darkened as in a movie theater, otherwise a clear picture cannot be obtained.</p> 
	Silver screen	<p>This type of screen gives a picture which is 2–4 times brighter than a white screen. A variety of types are available from different manufacturers, and each type has different brightness characteristics. Some also have restrictions on the possible range of viewing positions.</p> <ul style="list-style-type: none"> ※ Care should be taken with screens that have a high gain, as these types of screen can cause color distortion at the left and right edges. ※ This type of screen is recommended when the projector is suspended from the ceiling. 
	Beaded screen	<p>This type of screen is similar to the silver screen, except that no color distortion occurs at the left and right edges. Moreover, most of the light is reflected at the same angle as the angle of incidence.</p> <ul style="list-style-type: none"> ※ This type of screen is recommended when the projector is placed on the floor. 
Translucent screens	Flexible translucent screen	<p>This type of screen is made of PVC (polyvinyl chloride). It has the same characteristics as silver screens, but sometimes it can have hot spots.</p>
	Rigid-type translucent screen	<p>This type of screen is made of acrylic plastic. It is extremely durable and has excellent optical characteristics. It performs in the same way as silver screens.</p>

Standard setting-up positions

After determining the appropriate position for the projector by referring to the illustrations and standard setting-up dimensions given below, set up the projector. The distance **L** from the projector to the screen and the height **H** do not vary, regardless of whether the projector is being used in the floor, ceiling, front or rear positions.

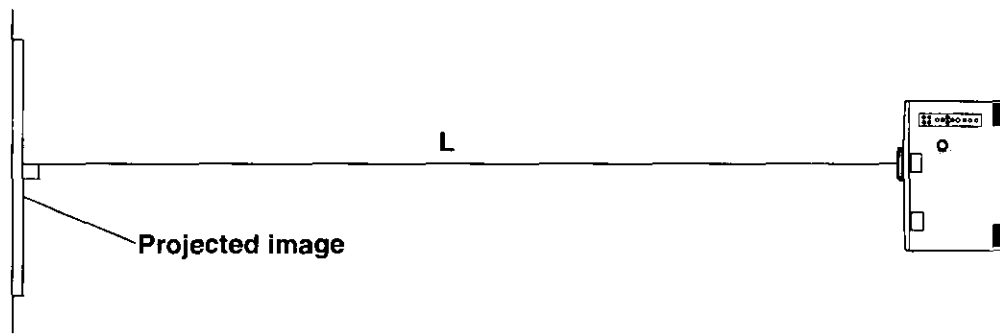
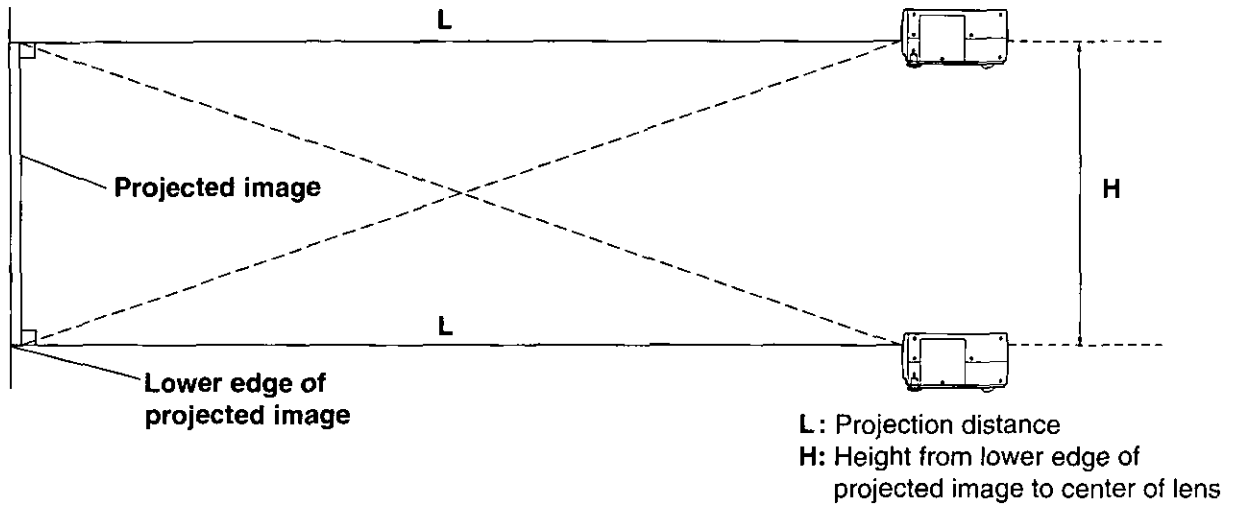

Standard setting-up dimensions

Because the projector uses an electronic zoom lens, it is possible to adjust the projection distance. And because there is also a function provided for adjusting the height of the lens, the height of the projector can also be adjusted relative to the position of the screen. For details, refer to pages 16 and 17.

Projection size	Projection distance (L)		Height from lower edge of projected image to center of lens (H)	Height from upper edge of projected image to center of lens (H)
	Minimum	Maximum		
30	4'8" (1.4 m)	5'3" (1.6 m)	0-18" (0-0.45 m)	0- -18" (0- -0.45 m)
40	5'11" (1.8 m)	6'11" (2.1 m)	0-24" (0-0.60 m)	0- -24" (0- -0.60 m)
60	8'7" (2.6 m)	10'6" (3.2 m)	0-36" (0-0.91 m)	0- -36" (0- -0.91 m)
80	11'2" (3.4 m)	14'2" (4.3 m)	0-48" (0-1.21 m)	0- -48" (0- -1.21 m)
100	13'10" (4.2 m)	17'5" (5.3 m)	0-60" (0-1.52 m)	0- -60" (0- -1.52 m)
150	20'5" (6.2 m)	26'3" (8.0 m)	0-90" (0-2.28 m)	0- -90" (0- -2.28 m)
200	27'3" (8.3 m)	34'10" (10.6 m)	0-120" (0-3.04 m)	0- -120" (0- -3.04 m)
250	33'10" (10.3 m)	43'8" (13.3 m)	0-150" (0-3.81 m)	0- -150" (0- -3.81 m)
300	40'1" (12.2 m)	52'2" (15.9 m)	0-180" (0-4.57 m)	0- -180" (0- -4.57 m)

NOTE:

- In addition, if the projector is not completely vertical with respect to the screen and horizontal with respect to the floor, distortion of the projected image will result. Adjust the projector horizon by the procedure given on page 17.
- The values in the table shown above are approximate.

□ Adjusting the position of the projected picture

The vertical position of the projected picture can be adjusted by changing the height of the projection lens using the LENS SHIFT dial which is on top of the projector.

After determining the projection distance and the setting-up position, adjust the vertical position of the projected picture by carrying out the following procedure.

Press the LENS SHIFT dial on top of the projector.The dial will pop up and it will be possible to turn it to make adjustments.

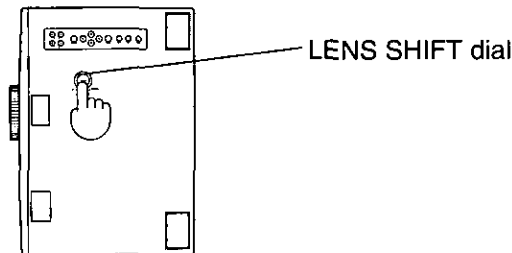

If the LENS SHIFT dial is turned clockwise, the position of the projected image will be raised.

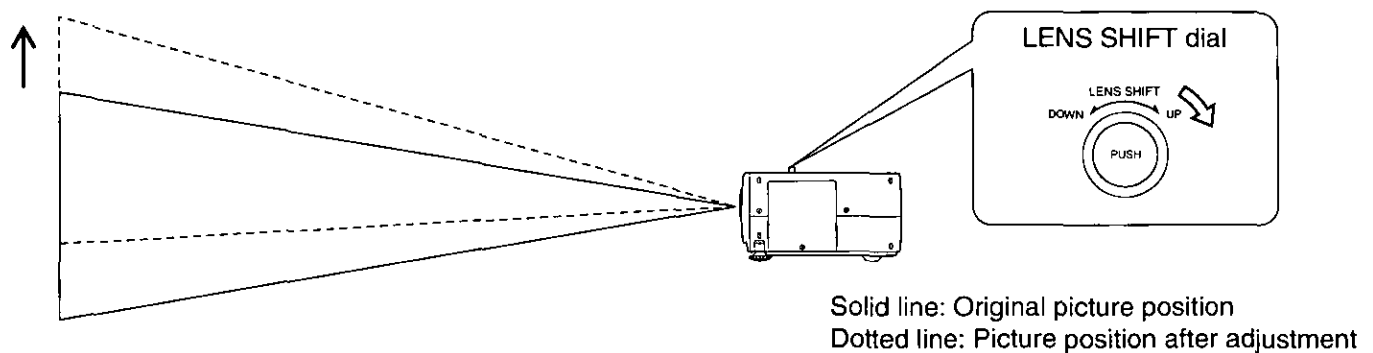

If the LENS SHIFT dial is turned counterclockwise, the position of the projected image will be lowered.

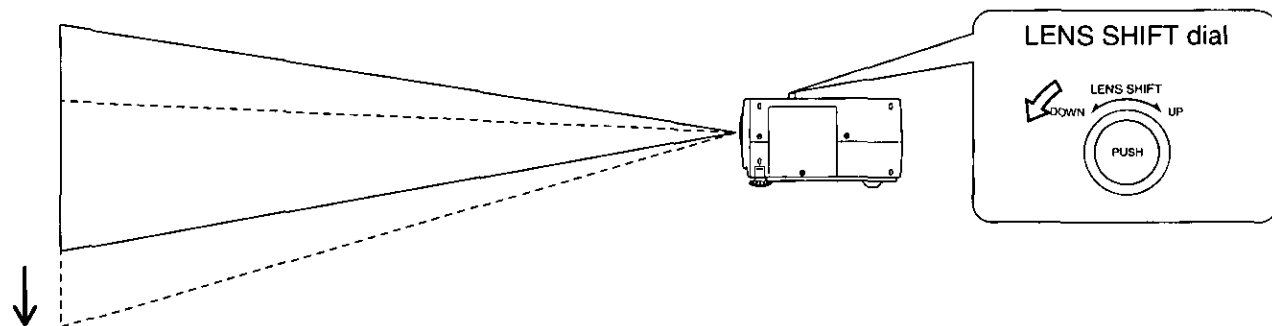

Press the LENS SHIFT dial on top of the projector.The dial will pop back in again and adjustment will no longer be possible.

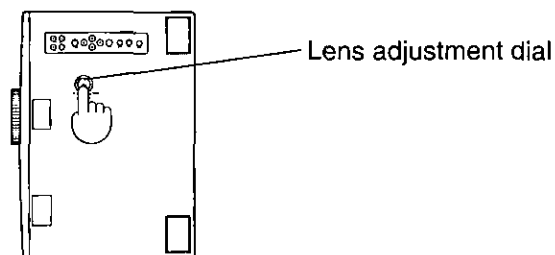

NOTE:

- The height of the projection lens can be adjusted within a range of $\pm 25/64$ inch (± 10.1 mm). However, the adjustment range for the position of the projected picture will vary depending on the size of the projected picture.

□ Setting the projector up horizontally

If the projector is not set up so that it is horizontal, it will not be possible to obtain a distortion-free picture. If placing the projector on top of a table or similar surface, carry out the following procedure below to ensure that no distortion of the picture occurs.

Adjustment procedure

1. Lift the front of the projector until the projector as a whole is horizontal. While holding it in this position, press the adjuster buttons under the sides of the projector (1 each at left and right). When the buttons are pressed, the left and right adjustable legs will drop down until they reach the setting-up surface.

NOTE:

- Do not release the buttons until both legs have reached the setting-up surface.

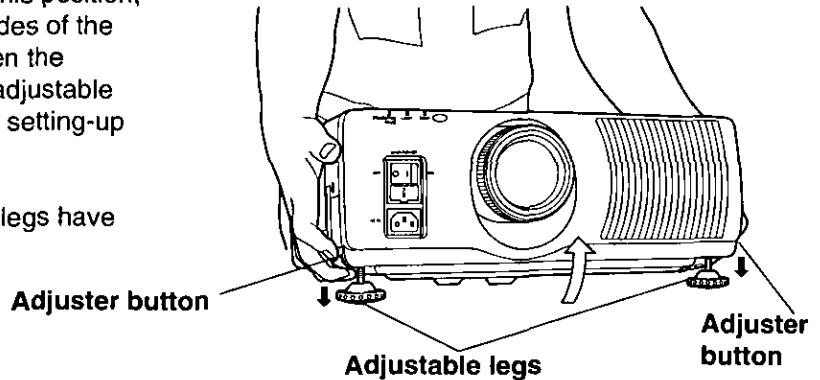

2. Release the adjuster buttons. (The adjustable legs will lock as soon as the buttons are released.)

3. Turn the adjustable legs by hand in either direction to make fine adjustments to the level of the projector so that the projector is perfectly horizontal.

NOTE:

- The legs can be extended by up to $2\frac{3}{8}$ " (60 mm). If you try to extend them any further than this, they will merely spin freely.

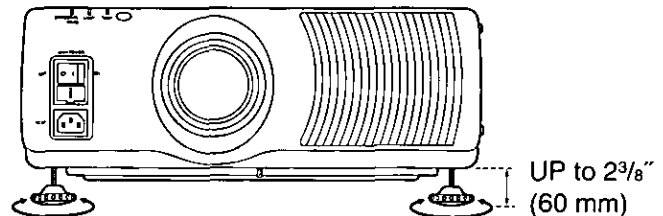

<Retracting the adjustable legs>

After lifting the front of the projector slightly, press and hold the adjuster buttons and then gently lower the projector.

NOTE:

- Be sure to support the projector firmly while pressing the adjuster buttons. If the adjuster buttons are pressed without supporting the projector, the adjustable legs will suddenly unlock and the projector will fall down, which could damage the projector.

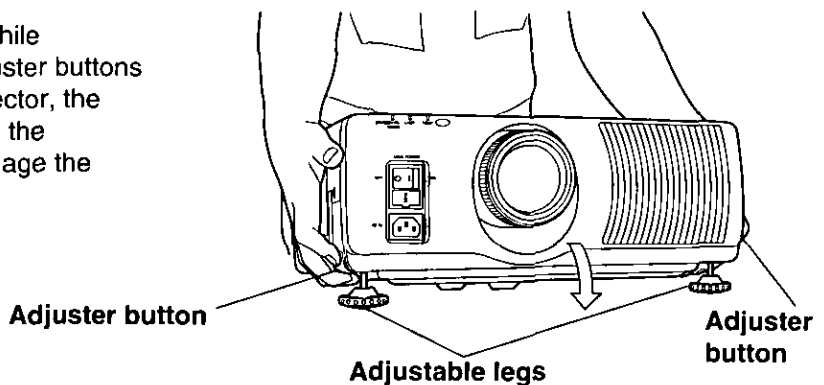

Adjusting the lens

This projection lens used in this projector is equipped with electronic zoom and electronic focus. These settings can be adjusted directly using the ZOOM button and the FOCUS button on the projector operating panel, or they can be adjusted by selecting "ZOOM/FOCUS" from the on-screen menu screen. In addition, focussing can be carried out manually by turning the focus ring on the projection lens.

NOTE:

- If direct adjustment is carried out while some other on-screen display is on the screen, the adjustment screen will not be displayed but the adjustment operation will still work.
- The projector is equipped with a function which retracts the lens when the projector power supply is turned off. However, the lens will not return to the previously-adjusted position when the power is turned back on again. Refer to page 36 for details on turning this function on and off.

Adjustment procedure <for direct adjustment>

1. Press the FOCUS +/- buttons on the projector operating panel to adjust the focus.

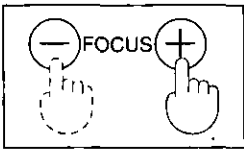

- Stop pressing the buttons when the picture image on the screen comes into the sharpest focus.

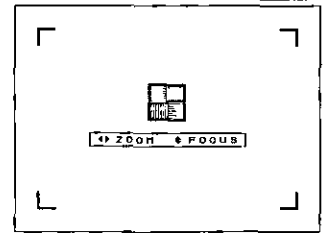

2. Press the ZOOM +/- buttons on the projector operating panel to adjust the picture size.

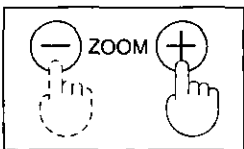

If "+" button is pressed ... the picture size becomes larger.

If "-" button is pressed ... the picture size becomes smaller.

Once the screen size reaches the maximum or minimum size, display arrows appear in red in the four corners of the picture image.

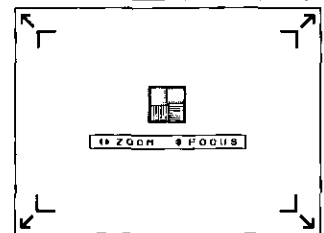

3. Press the FOCUS +/- buttons to make fine adjustments to the focus.

NOTE:

- If approximately five seconds pass without any buttons being pressed, the adjustment screen will be cleared.

Adjustment procedure <for adjustment using the on-screen menu screens>

1. Press the MENU button. ... The MENU screen will be displayed.
2. Use the "▲" and "▼" arrow buttons to move the cursor to "ZOOM/FOCUS".

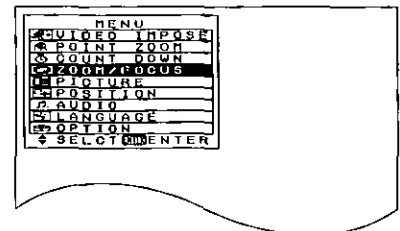

3. Press the ENTER button. ... The ZOOM/FOCUS individual adjustment screen will be displayed.

4. Use the "▲" and "▼" arrow buttons to adjust the focus.
5. Use the "◀" and "▶" arrow buttons to adjust the screen size.

If "▶" button is pressed ... the picture size becomes larger.

If "◀" button is pressed ... the picture size becomes smaller.

Once the screen size reaches the maximum or minimum size, display arrows appear in red in the four corners of the picture image.

6. Use the "▲" and "▼" arrow buttons to make fine adjustments to the focus.

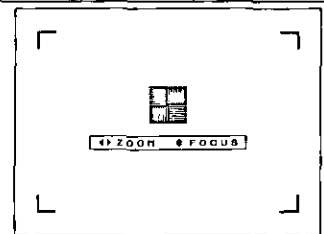

NOTE:

- If no button is pressed for approximately 5 seconds while an individual adjustment screen is being displayed, the display will return to the MENU screen.
- If the MENU button is pressed, the display will return to the MENU screen, or the MENU screen will be cleared if it is already being displayed.

Setting-up positions and changing the projection method

The projection method used by the projector can be changed in accordance with the setting-up position. At the time of shipment from the factory, the projector is set to the "FRONT" projection method, but this can be changed if required.

Setting procedure

1. Press the MENU button to display the MENU screen.
2. Press the "▲" and "▼" buttons to select "OPTION".

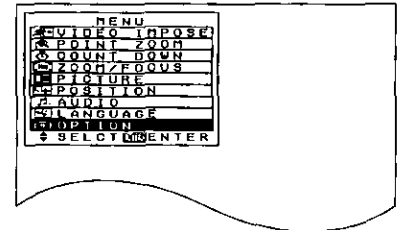

3. Press the ENTER button to display the OPTION screen.
4. Press the "▲" and "▼" buttons to select "FRONT/REAR".
5. Press the "◀" and "▶" buttons to select "FRONT" or "REAR".

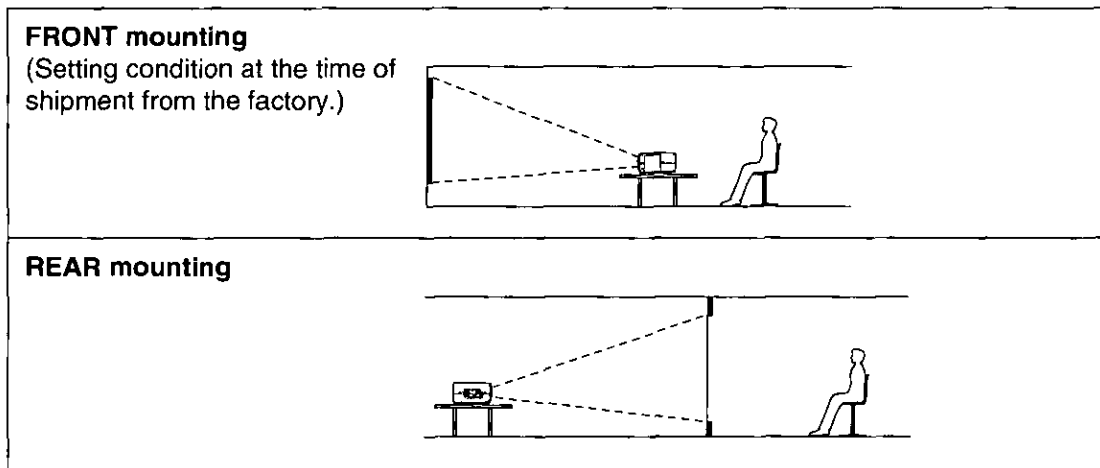
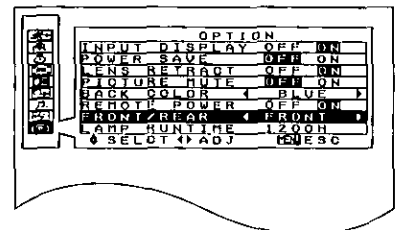

NOTE:

- If the MENU button is pressed, the display will return to the MENU screen, or the MENU screen will be cleared if it is already being displayed.

Basic operation

□ Changing the input signal

The input source for picture signals and the corresponding audio signals can be changed by pressing the VIDEO or RGB buttons on the projector operating panel or on the remote control unit. In addition, the name of the input source selected will be displayed on the screen for approximately 5 seconds.

Press the VIDEO button

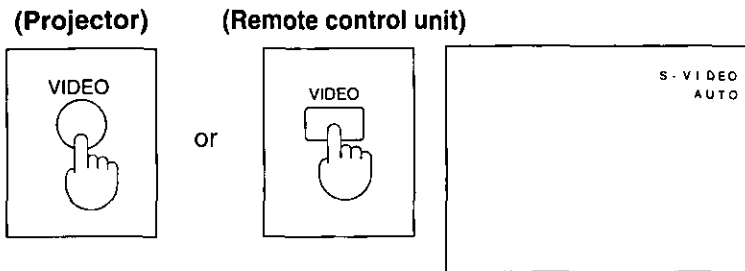

The signal from the source which is connected to the S-VIDEO IN connector or VIDEO IN connector is projected.

If cables are connected to both connectors, the S-VIDEO signal will be selected automatically. (The S-VIDEO signal has priority.)

Press the RGB button

(The source switches between RGB 1 and RGB 2 each time the button is pressed.)

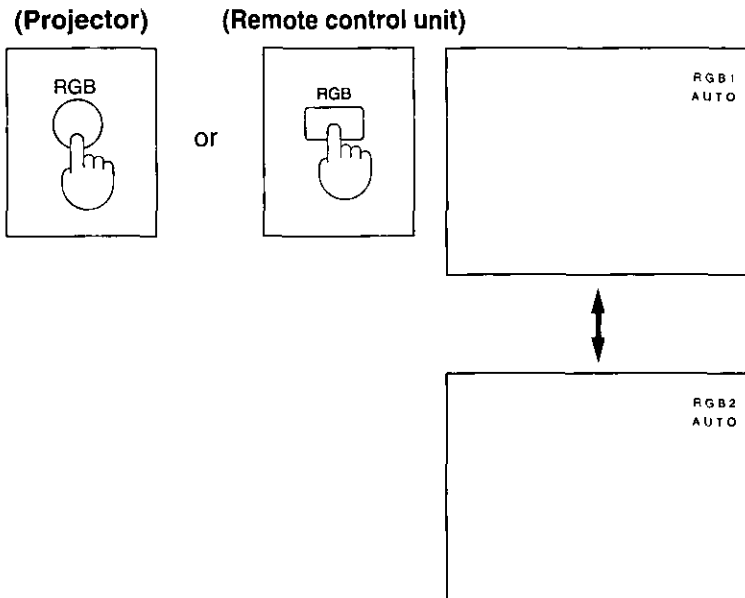

The signal from the source which is connected to the RGB 1 IN connector is projected.

The signal from the source which is connected to the RGB 2 IN connector is projected.

NOTE:

- The mode or format (TV-SYSTEM) of the currently-selected signal will be displayed on-screen underneath the name of the selected signal source. Refer to page 34 for details on how to clear the on-screen display of the signal source name.
- If you would like to project the VIDEO signals being input to the VIDEO IN connector, do not connect any cables to the S-VIDEO IN connector.
- There is only one audio system circuit provided for the AUDIO IN L-R terminals for S-VIDEO and VIDEO signals. Because of this, if using both S-VIDEO signals and VIDEO signals, it will be necessary to change over the connectors.
- When RGB signals are being input, the projection mode will be matched automatically to one of the modes which have been pre-set inside the projector.
- The projector is shipped from the factory with the system format selection function set to "AUTO", so that the system format is selected automatically when VIDEO/S-VIDEO signals are being input.
- Refer to page 21 for a list of the different types of RGB signal which can be input, and to page 22 for details on the format selection when VIDEO/S-VIDEO signals are being input.
- When RGB 1 or RGB 2 has been selected, the signal selected will be output from the RGB OUT connector.

<RGB signals that can be input>

The table below lists the different types of RGB signals that can be input.

If a signal which differs greatly from any of the types listed below is input, the picture image may not be displayed correctly, or a blue background (or black background) may be displayed.

Display mode name	Signal data		
	No. of dots	Horizontal scanning frequency(kHz)	Vertical scanning frequency(Hz)
VGA400	640 × 400	24.8	56.4
	640 × 400	31.5	70.1
VGA480	640 × 480	31.5	59.9
	640 × 480	35.0	66.7
	640 × 480	37.9	72.8
	640 × 480	37.5	75.0
	640 × 480	43.3	85.0
SVGA	800 × 600	32.1	51.0
	800 × 600	35.2	56.3
	800 × 600	37.9	60.3
	800 × 600	48.1	72.1
	800 × 600	46.9	75.0
XGA	800 × 600	53.7	85.1
	1024 × 768	48.4	60.0
	1024 × 768	56.5	70.1
	1024 × 768	60.0	75.0
	1024 × 768	65.5	81.6
	1024 × 768	68.7	85.0
	1024 × 768i	35.5	86.8
MXGA	1024 × 768	80.7	100.8
	1152 × 864	63.9	70.0
	1152 × 864	67.5	75.0
	1152 × 864	77.1	85.0
	1120 × 750	50.1	60.1
SXGA	1120 × 750i	32.6	80.0
	1280 × 1024	52.4	50.0
	1280 × 1024	64.0	60.0
	1280 × 1024	72.4	66.3
	1280 × 1024	78.2	71.7
	1280 × 1024	80.0	75.0
	1280 × 1024i	46.2	86.0
1280 × 1024i	47.6	88.9	
MAC16	832 × 624	49.7	74.6
MAC21	1152 × 870	68.6	75.0
HDTV	960 × 1035i	33.8	60.0

NOTE:

- The display resolution of this projector is 1024 × 768 dots. If the display resolution indicated in the above data exceeds this resolution, the resolution will be converted to 1024 × 768 dots.
- Display resolutions followed by a "i" indicate interlaced signals.

<Checking the display mode for RGB signals>

Use the following procedure to check the display mode for the RGB signals which are currently being input.

Operating procedure

1. Press the MENU button. ... The MENU screen will be displayed.
2. Use the “▲” and “▼” arrow buttons to move the cursor to “PICTURE”.

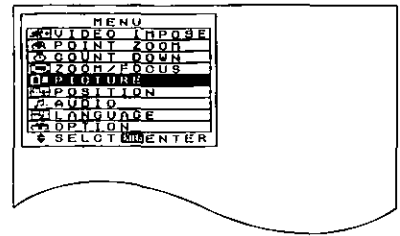

3. Press the ENTER button. ... The PICTURE screen will be displayed.
 - The display mode for the RGB signals which are currently being input will appear in the “SIGNAL MODE” item.

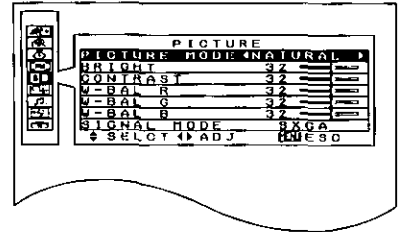

NOTE:

- If the MENU button is pressed, the display will return to the MENU screen, or the MENU screen will be cleared if it is already being displayed.

<VIDEO/S-VIDEO signal format selection>

If the correct signal format is not selected and the picture does not appear as normal when VIDEO or S-VIDEO signals are being input, select the format by the following procedure. This function is set to “AUTO” at the time of shipment from the factory, so that the projector can normally be used with this setting left as it is.

Operating procedure

1. Press the MENU button. ... The MENU screen will be displayed.
2. Use the “▲” and “▼” arrow buttons to move the cursor to “PICTURE”.

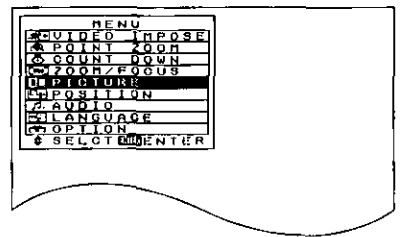

3. Press the ENTER button. ... The PICTURE screen will be displayed.
4. Use the “▲” and “▼” arrow buttons to move the cursor to “TV-SYSTEM”.
5. Use the “◀” and “▶” arrow buttons to switch the setting to “AUTO”, “NTSC”, “NTSC4.43”, “PAL”, “PAL-M”, “PAL-N” or “SECAM” until a normal picture is obtained.

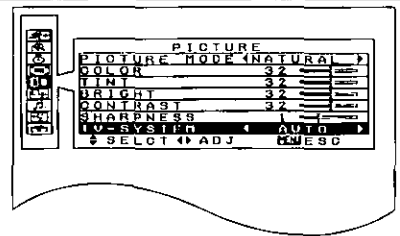

	Horizontal scanning frequency [kHz]	Vertical scanning frequency [Hz]	Color subcarrier frequency [MHz]
AUTO	“NTSC”, “NTSC4.43”, “PAL”, “PAL-M”, “PAL-N” or “SECAM” is selected automatically.		
NTSC	15.75	60.00	3.58
NTSC4.43			4.43
PAL	15.63	50.00	3.58
PAL-M	15.75	60.00	
PAL-N	15.63	50.00	
SECAM			4.25 or 4.41

NOTE:

- If using a signal source with poor picture quality, such as a dubbed tape, it may not be possible to get the picture to display properly.
- If the MENU button is pressed, the display will return to the MENU screen, or the MENU screen will be cleared if it is already being displayed.
- NTSC and PAL-M have the same scanning frequencies and color sub-carrier frequencies, but they have different color modulation methods. Because of this, if the incorrect setting is selected, color pictures may appear in black-and-white.

□ Freezing the picture

Projection can be switched between a frozen (still) picture and a moving picture each time the FREEZE button on the remote control unit is pressed.

(Remote control unit)

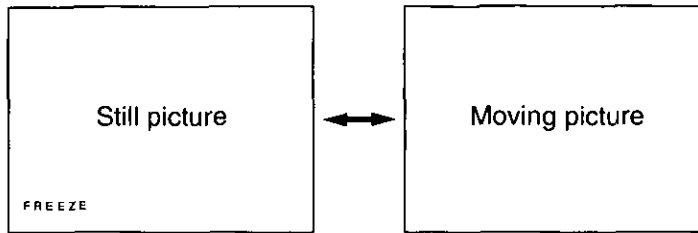
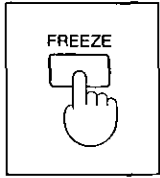

NOTE:

- Picture adjustments, position adjustments and video impose and POINT ZOOM operations cannot be carried out while a still picture is being displayed.

□ Returning adjustment values to the factory default settings (standard values)

If the STD button on the remote control unit is pressed while the PICTURE screen, POSITION screen or AUDIO screen is being displayed, or while an individual adjustment screen is being displayed, the adjustment values will be returned to their standard values at the time of shipment from the factory.

(Remote control unit)

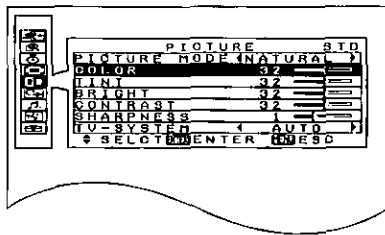
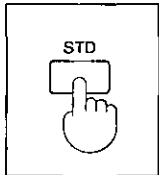

While the PICTURE or POSITION screen is being displayed ... "STD" will appear in green in the top-right corner of the screen, and the value being adjusted will be returned to the standard value.

While the AUDIO screen is being displayed ... "STD" will appear in green in the top-right corner of the screen, and only the BALANCE setting will be returned to the standard value.

While an individual adjustment screen is being displayed ... The adjustment level will be displayed in green and only the item displayed will be returned to the standard value.

NOTE:

- The TV-SYSTEM setting in the PICTURE screen (when VIDEO/S-VIDEO signals are being input) and the VOLUME setting in the AUDIO screen will not return to the standard values when the STD button is pressed.

□ Adjusting the volume

The volume can be adjusted using the VOL +/- buttons on the remote control unit.

(Remote control unit)

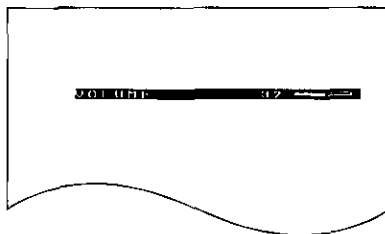
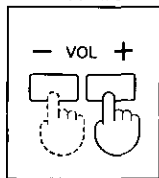

If "+" button is pressed ... the volume becomes louder.
If "-" button is pressed ... the volume becomes quieter.

- If audio equipment is connected to the AUDIO OUT terminal, the output level from this terminal will be adjusted.

NOTE:

- During volume adjustment, the output level will be displayed on the screen for approximately 5 seconds.
- Volume adjustment can also be carried out by selecting AUDIO from the on-screen menu screen. Refer to page 27 for further details.
- If this button is pressed while some other on-screen display is on the screen, the adjustment level and the bar scale will not be displayed but the adjustment operation will still work.

□ Turning off the sound

If the MUTE button on the remote control unit is pressed, "MUTE" will be displayed on the screen as shown in the illustration below and the sound will be muted. If the MUTE button is pressed once more, the on-screen display will be cleared and the normal sound volume will be restored. The volume output level will remain displayed on the screen for approximately three seconds.

Remote control unit

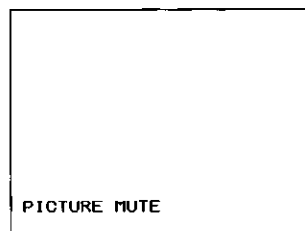
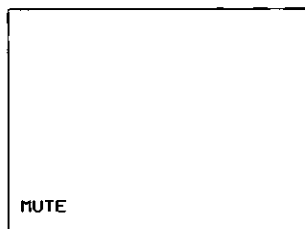
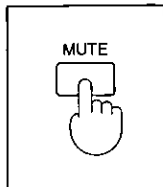

NOTE:

- If the MUTE button is pressed while the on-screen display for another function is currently on the screen, the volume will still be muted but the "MUTE" on-screen display will not appear.
- If the power supply is turned off or either of the VOL (+/-) buttons is pressed, the mute setting will be canceled.
- It is also possible to have the picture turn off together with the sound when the MUTE button is pressed. Refer to page 37 for details on how to change this setting. When the picture has been turned off in this way, the words "PICTURE MUTE" will be displayed on the screen.

Selecting the picture mode

In order to obtain better picture quality, two types of picture mode are available for VIDEO/S-VIDEO signals and RGB signals.

Use the procedure given below to select the desired mode (NATURAL/DYNAMIC).

Setting procedure

1. Press the MENU button. ... The MENU screen will be displayed.
2. Use the "▲" and "▼" arrow buttons to move the cursor to "PICTURE".

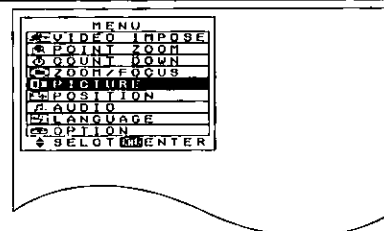

3. Press the ENTER button. ... The PICTURE screen will be displayed.
4. Use the "▲" and "▼" arrow buttons to move the cursor to "PICTURE MODE".
5. Use the "◀" and "▶" arrow buttons to switch the setting to "NATURAL" or "DYNAMIC" until the best picture is obtained.

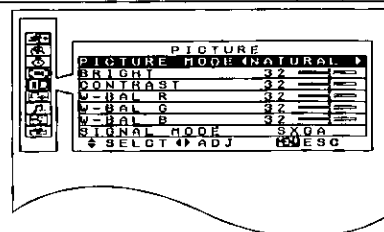

NATURAL: The picture obtained is appropriate when using this projector in places with standard brightness.

DYNAMIC: The picture obtained is appropriate when using this projector in brighter places.

NOTE:

- Once a picture mode is selected by the above procedure, the picture can then be adjusted further as desired. Refer to the following page for details on adjustment methods.
- If the MENU button is pressed, the display will return to the MENU screen, or the MENU screen will be cleared if it is already being displayed.
- If the STD button is pressed while the PICTURE screen is being displayed, "STD" will be displayed in the top-right corner of the screen and the adjustment value being displayed (except for TV-SYSTEM) will be returned to the factory default setting in accordance with the picture mode selected.

Adjusting the picture to the desired setting

You can adjust the picture settings for any of the input signal sources selected according to the procedure on page 20. The items which can be adjusted vary depending on the type of input signal. The adjustment procedure below describes the on-screen displays when the S-VIDEO signal or the VIDEO signal is being projected.

Adjustment procedure <for the COLOR setting>

1. Press the MENU button to display the MENU screen.
2. Press the "▲" and "▼" buttons to select "PICTURE".

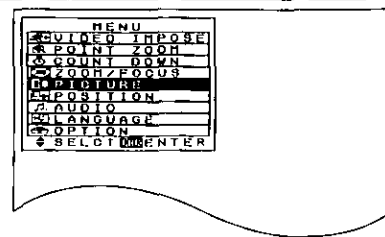

3. Press the ENTER button to display the PICTURE screen.
4. Press the "▲" and "▼" buttons to select "COLOR".

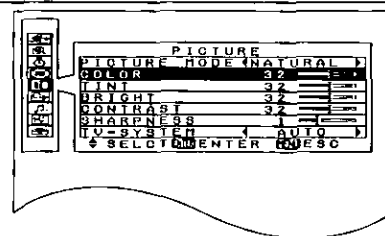

5. Press the ENTER, "◀" or "▶" button to display the COLOR individual adjustment screen.
6. Continue pressing the "◀" and "▶" buttons to adjust the color. The current setting will be displayed on the screen by numerals and a bar.
 - The adjustment operation and the changes made will vary depending on which adjustment item is selected. Refer to the table below for details.

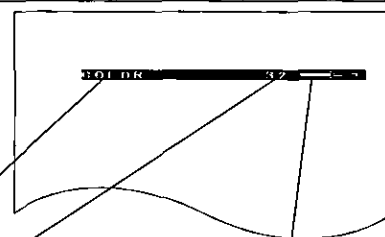

Adjustment function display

Numeric adjustment level display

Bar display

Adjustment Item	Button	Adjustment Details	Adjustment Range	Remarks
COLOR	Press the "▶" button.	The color becomes darker.	Max. value 63	S-VIDEO/VIDEO only
	Press the "◀" button.	The color becomes lighter.	Min. value 0	
TINT	Press the "▶" button.	Flesh tones become greenish.	Max. value 63	NTSC, NTSC 4.43 (S-VIDEO/VIDEO) only
	Press the "◀" button.	Flesh tones become reddish.	Min. value 0	
BRIGHT	Press the "▶" button.	The screen becomes brighter.	Max. value 63	
	Press the "◀" button.	The screen becomes darker.	Min. value 0	
CONTRAST	Press the "▶" button.	The screen becomes brighter and the picture becomes darker.	Max. value 63	
	Press the "◀" button.	The screen becomes darker and the picture becomes lighter.	Min. value 0	
SHARPNESS	Press the "▶" button.	The picture quality becomes sharper.	Max. value 3	S-VIDEO/VIDEO only
	Press the "◀" button.	The picture quality becomes softer.	Min. value 0	

NOTE:

- If no button is pressed for approximately 5 seconds while an individual adjustment screen is being displayed, the display will return to the PICTURE screen.
- If the MENU button is pressed, the display will return to the MENU screen, or the MENU screen will be cleared if it is already being displayed.
- Refer to page 22 for details on the TV-SYSTEM settings which appear in the PICTURE screen, and to page 24 for the PICTURE MODE settings.
- Refer to the next page for details on adjustment of the WHITE BALANCE R/G/B (W-BAL-R/G/B) settings which appear when RGB signals are being input and the PICTURE screen is being displayed.

Adjusting the white balance

When RGB signals from a personal computer or other signal source are being projected, the picture may become over-saturated with red or blue color, and the white color may not be at the desired degree of whiteness. In such cases, adjust the white balance by the following procedure. (Only effective when RGB signals are being projected.)

Adjustment procedure <for white balance adjustment of the red component>

1. Press the MENU button to display the MENU screen.
2. Press the “▲” and “▼” buttons to select “PICTURE”.

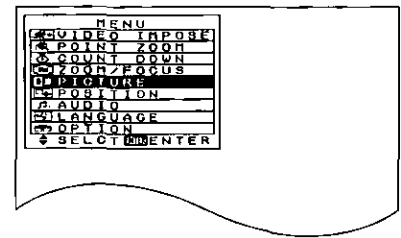

3. Press the ENTER button to display the PICTURE screen.
4. Press the “▲” and “▼” buttons to select “W-BAL R”.

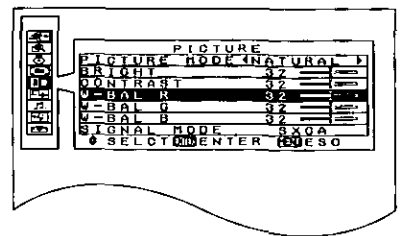

5. Press the ENTER, “◀” or “▶” button to display the W-BAL R individual adjustment screen.
6. Continue pressing the “◀” and “▶” buttons to adjust the W-BAL R setting. The current setting will be displayed on the screen by numerals and a bar.

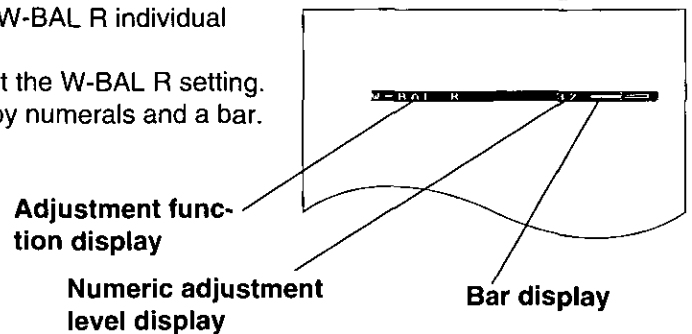

Adjustment Item	Button	Adjustment Details	Adjustment Range
W-BAL R	Press the “▶” button.	The red component becomes stronger.	Max. value 63 Min. value 0
	Press the “◀” button.	The red component becomes weaker.	
W-BAL G	Press the “▶” button.	The green component becomes stronger.	
	Press the “◀” button.	The green component becomes weaker.	
W-BAL B	Press the “▶” button.	The blue component becomes stronger.	
	Press the “◀” button.	The blue component becomes weaker.	

NOTE:

- If these adjustments are not made correctly, none of the colors will be reproduced correctly. If you make an error in adjustment so that the colors do not match correctly, press the STD (Standard) button while one of the individual adjustment screens is being displayed. The value and the bar display will appear in yellow and only the item being displayed will be reset to the factory pre-setting.
- If the MENU button is pressed, the display will return to the MENU screen, or the MENU screen will be cleared if it is already being displayed.
- Separate adjustments can be carried out for RGB 1 and RGB 2.

Adjusting the sound to the desired setting

You can adjust the volume and balance to the desired settings.

Adjustment procedure <for volume adjustment>

1. Press the MENU button to display the MENU screen.
2. Press the “▲” and “▼” buttons to select “AUDIO”.

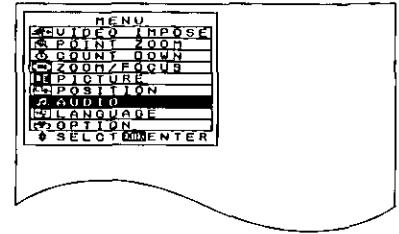

3. Press the “◀” and “▶” buttons to display the AUDIO screen.
4. Press the “▲” and “▼” buttons to select “VOLUME”.
 - To adjust the balance, select “BALANCE” instead.

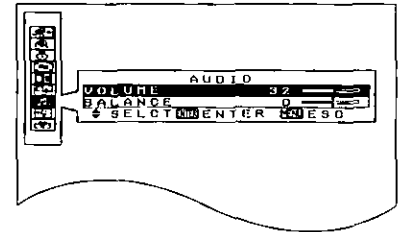

5. Press the ENTER, “◀” or “▶” button to display the VOLUME individual adjustment screen.
6. Continue pressing the “◀” and “▶” buttons to adjust the volume setting. The current setting will be displayed on the screen by numerals and a bar.
 - The adjustment range is between 0 and 63. (However, the adjustment range for the balance setting is -32+31.)
 - While “VOLUME” is selected, the volume of the sound coming from the built-in speakers and the output level of the signal from the AUDIO OUT terminal will change.
 - While “BALANCE” is selected, the left and right balance of the sound coming from the built-in speaker and the output level of the signal from the AUDIO OUT terminal will change.

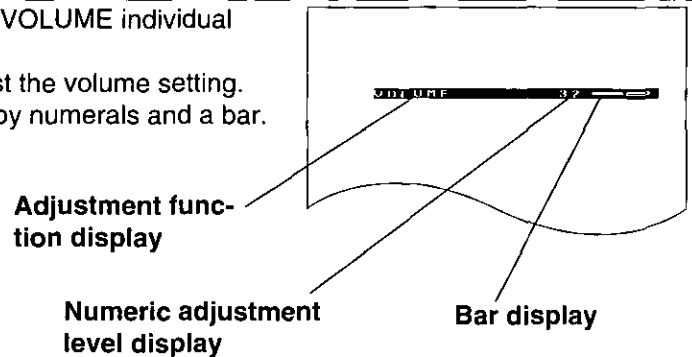

NOTE:

- If no button is pressed for approximately 5 seconds while an individual adjustment screen is being displayed, the display will return to the AUDIO screen.
- If the MENU button is pressed, the display will return to the MENU screen, or the MENU screen will be cleared if it is already being displayed.
- Volume adjustment from the AUDIO screen works in exactly the same way as using the VOL +/- volume adjustment buttons on the remote control unit.
- If audio equipment is connected to the AUDIO OUT terminal, no sound will be output from the projector's built-in speakers, and the output level from the AUDIO OUT terminal will be adjusted. However, if the volume adjustment level is set to “0”, no audio signal will be output.

Correcting the picture position automatically

When a picture consisting of RGB signals is being projected from a source such as a personal computer, the horizontal position, vertical position, dot clock and clock phase can all be adjusted simultaneously. (This is only possible when RGB signals are being projected.)

Follow the procedure given below to use this function.

Correction procedure

1. Input a picture which consists of a screen full of black lettering or black lines from the connected video signal source.

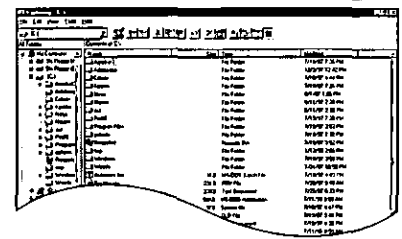

2. Press the MENU button. ... The MENU screen will be displayed.
3. Use the "▲" and "▼" arrow buttons to move the cursor to "POSITION".

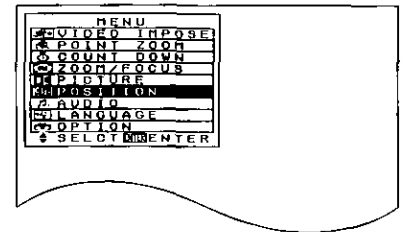

4. Press the ENTER button. ... The POSITION screen will be displayed.
5. Use the "▲" and "▼" arrow buttons to move the cursor to "AUTO SETUP".

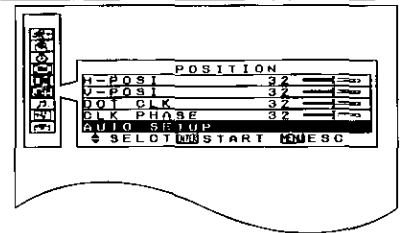

6. Press the ENTER button. ... The automatic position correction operation will then start.

NOTE:

- If the edges of the picture image cannot be determined, or if a dark picture is being input when using the automatic position correction operation, "AUTO SETUP INCOMPLETE" will be displayed. In such cases, press the MENU button to return to the POSITION screen, change the picture to one such as that listed in step 1., and then repeat the operation.
- If a signal with a resolution greater than 1024 × 768 dots is being input, automatic clock phase correction will not be possible. If any distortion or uneven contours appear in the picture, adjust the clock phase while referring to page 31.
- During automatic position correction operations, the characters "AUTO SETUP" will display on the screen.
- Once automatic position correction completes normally, the display will return to the POSITION screen.
- If the MENU button is pressed during automatic position correction, automatic position correction will be stopped and the display will return to the POSITION screen.
- The use of automatic position correction may not be possible with some types of personal computer.
- Automatic position correction can be carried out for different input signals, and the corrected values will be stored in memory.

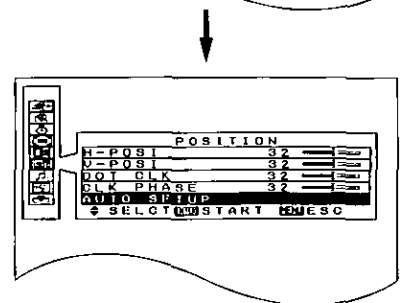

Adjusting the picture position

If the picture is not correctly positioned within the display area of the screen so that part of the edge of the picture does not appear, adjust the position of the picture.

The adjustment procedure below describes the on-screen displays when an S-VIDEO or VIDEO signal is being projected.

Adjustment procedure <for horizontal position adjustment>

1. Press the MENU button to display the MENU screen.
2. Press the "▲" and "▼" buttons to select "POSITION".

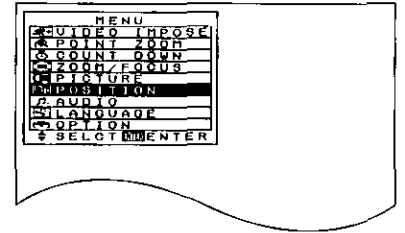

3. Press the ENTER button to display the POSITION screen.
4. Press the "▲" and "▼" buttons to select "H-POSI".
 - To adjust the vertical position of the picture, select "V-POSI" instead.

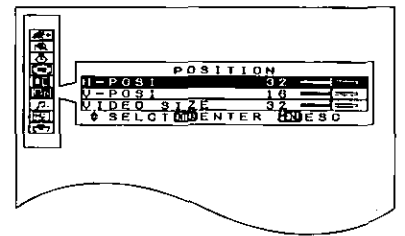

5. Press the ENTER, "◀" or "▶" button to display the H-POSI individual adjustment screen.
6. Continue pressing the "◀" and "▶" buttons to adjust the H-POSI setting. The current setting will be displayed on the screen by numerals and a bar.

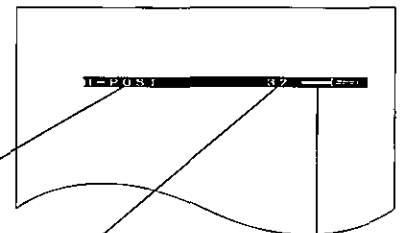

Adjustment function display

Numeric adjustment level display

Bar display

<When adjusting the horizontal position (H-POSI)>

If the "▶" button is pressed, the picture moves to the right.

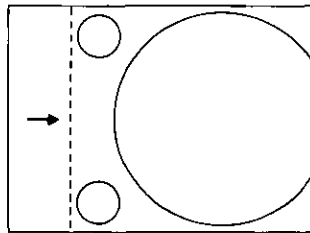

If the "◀" button is pressed, the picture moves to the left.

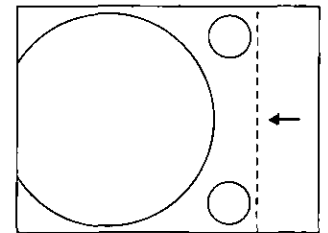

<When adjusting the vertical position (V-POSI)>

If the "▶" button is pressed, the picture moves up.

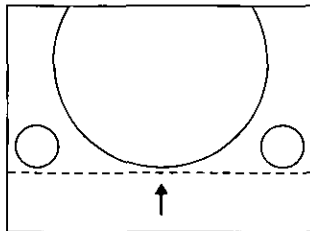

If the "◀" button is pressed, the picture moves down.

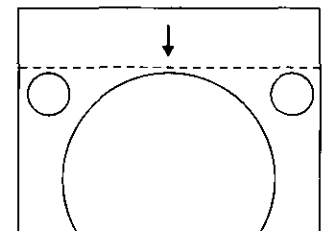

NOTE:

- If approximately five seconds pass without any buttons being pressed while an individual adjustment screen is being displayed, the display will return to the POSITION screen.
- If the MENU button is pressed, the display will return to the MENU screen, or the MENU screen will be cleared if it is already being displayed.

Adjusting the video size

The video size can be adjusted to overscan and underscan sizes only when an S-VIDEO or VIDEO signal is being projected. Adjust by the following procedure.

Adjustment procedure

1. Press the MENU button to display the menu screen.
2. Press the "▲" and "▼" buttons to select "POSITION".

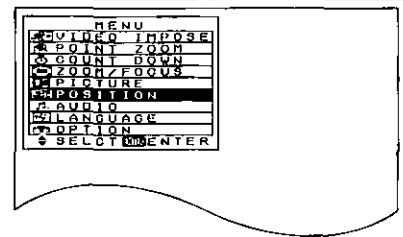

3. Press the ENTER button to display the POSITION screen.
4. Press the "▲" and "▼" buttons to select "VIDEO SIZE".

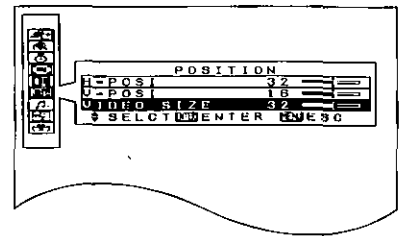

5. Press the ENTER, "◀" or "▶" button to display the VIDEO SIZE individual adjustment screen.
6. Continue pressing the "◀" and "▶" buttons to adjust the VIDEO SIZE setting. The current setting will be displayed on the screen by numerals and a bar.

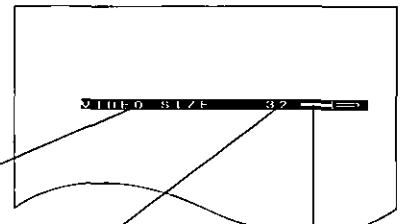

Adjustment function display

Numeric adjustment level display

Bar display

<For overscanning>

Press the "▶" arrow button.
... The picture will extend to the right and downward.

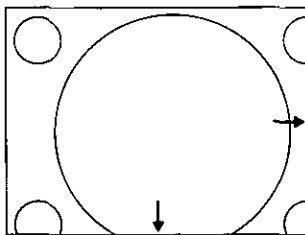

<For underscanning>

Press the "◀" arrow button.
... The picture will contract to the left and upward.

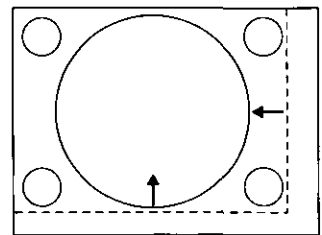

NOTE:

- If video size adjustment results in the picture position tending to one side, adjust the position while referring to page 29.
- If no button is pressed for approximately 5 seconds while an individual adjustment screen is being displayed, the display will return to the POSITION screen.
- If the MENU button is pressed, the display will return to the MENU screen, or the MENU screen will be cleared if it is already being displayed.

About dot clock adjustment

When RGB signals are being input, you can make fine adjustments to the dot clock frequency and also adjust the clock phase. Adjustments are made by the following procedure while viewing the picture. (This is only effective when RGB signals are being projected.)

Adjusting the dot clock frequency

When RGB signals are being input, you can adjust the display area of pictures sent from a computer.

Adjustment procedure

The procedure below starts from the POSITION screen.

1. Press the "▲" and "▼" buttons to select "DOT CLK".

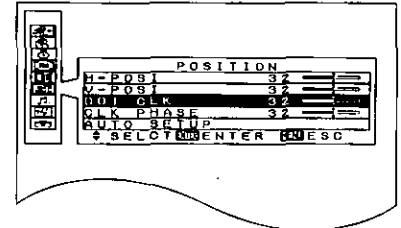

2. Press the ENTER, "◀" or "▶" button to display the DOT CLK individual adjustment screen.
3. Continue pressing the "◀" and "▶" buttons to adjust the DOT CLK setting. The current setting will be displayed on the screen by numerals and a bar.

Adjustment function display

Numeric adjustment level display

Bar display

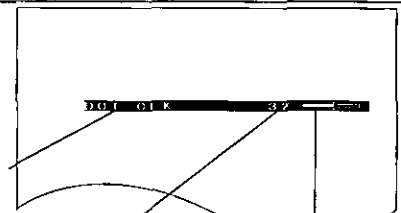

Adjusting the clock phase

You can use this adjustment to eliminate the flicker (localized noise) that appears on the computer screens when RGB signals are projected.

Adjustment procedure

The procedure below starts from the POSITION screen.

1. Press the "▲" and "▼" buttons to select "CLK PHASE".

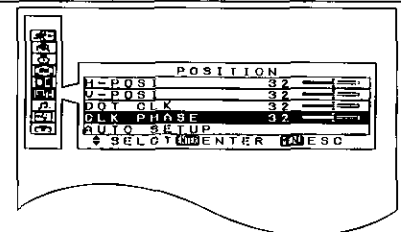

2. Press the ENTER, "◀" or "▶" button to display the CLK PHASE individual adjustment screen.
3. Continue pressing the "◀" and "▶" buttons to adjust the CLK PHASE setting. The current setting will be displayed on the screen by numerals and a bar.

Adjustment function display

Numeric adjustment level display

Bar display



NOTE:

- If approximately five seconds pass without any buttons being pressed while an individual adjustment screen is being displayed, the display will return to the POSITION screen.
- If the MENU button is pressed, the display will return to the MENU screen, or the MENU screen will be cleared if it is already being displayed.
- If the STD (Standard) button is pressed while one of the individual adjustment screens is being displayed, the value and the bar display will appear in yellow and only the item displayed will be reset to the factory pre-setting.
- Separate adjustment is possible for each input signal, and the results of adjustment are stored in memory.

Using other useful functions

□ Using the video impose function

This projector can be used to display a VIDEO/S-VIDEO signal image in a sub-screen on an RGB image (video impose).

Setting procedure

1. Press the MENU button. ... The MENU screen will be displayed.
2. Use the “▲” and “▼” arrow buttons to move the cursor to “VIDEO IMPOSE”.

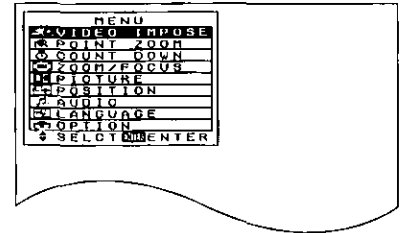

3. Press the ENTER button. ... The VIDEO IMPOSE screen will be displayed.

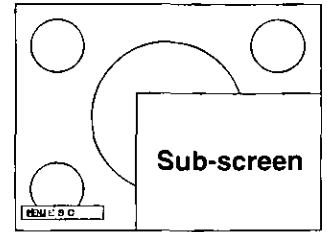

The position of the sub-screen can be changed by pressing the “▲”, “▼”, “◀” and “▶” arrow buttons.

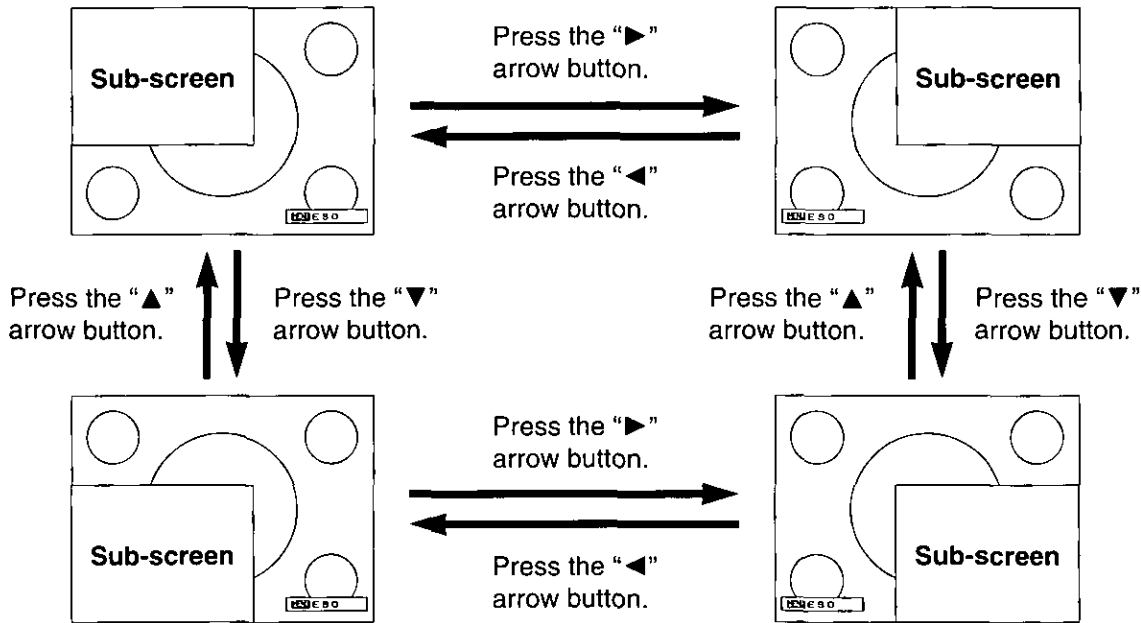

NOTE:

- The video impose function is only effective when RGB signals are being input.
- If the FREEZE button is pressed before VIDEO IMPOSE is selected, the video impose function will not operate.
- If the MENU button is pressed, the display will return to the MENU screen, or the MENU screen will be cleared if it is already being displayed.
- If the VIDEO button or the RGB button is pressed while the video impose function is operating, the video impose function will be canceled and the screen will switch back to projecting the input video signal.
- If the FREEZE button is pressed while the video impose function is operating, a still picture can be obtained. However, the input source cannot be switched and the MENU button will not operate until the FREEZE button is pressed once more to cancel the still picture.

□ Enlarging part of the input picture

It is possible to enlarge and project one section of the input picture, and to select the enlargement ratio for this enlarged section. (When a VIDEO or an S-VIDEO signal is being projected, the enlargement ratio is fixed at $\times 2$.)

Operating procedure

1. Press the MENU button. ... The MENU screen will be displayed.
2. Use the "▲" and "▼" arrow buttons to move the cursor to "POINT ZOOM".

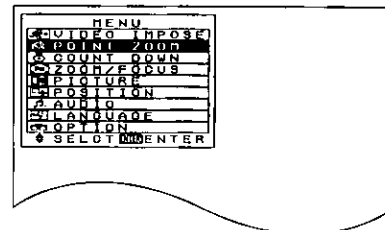

3. Press the ENTER button. ... The enlargement area selection screen will be displayed. (A box allowing you to select the area to be enlarged will be displayed.)
4. Use the "▲", "▼", "◀" and "▶" arrow buttons to move the box to the area to be enlarged.
Use the "▲" and "▼" arrow buttons to move the box up and down.
Use the "◀" and "▶" arrow buttons to move the box to the left and right.

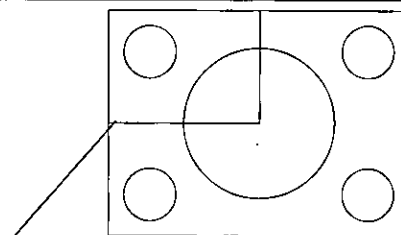

Enlargement area selection box

5. Press the STD button to select the enlargement ratio.
If $\times 2$ enlargement is selected, the box will become larger, and if $\times 3$ enlargement is selected, the box will become smaller.

NOTE:

- The enlargement ratio can be set to $\times 2$ enlargement or $\times 3$ enlargement by pressing the STD button only when the enlargement area selection box is displayed or the enlargement picture is displayed.

6. Press the ENTER button. ... The enlarged picture will be displayed.

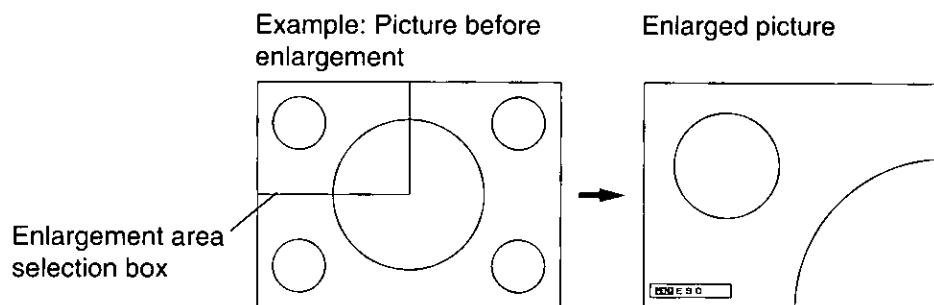

7. Use the "▲", "▼", "◀" and "▶" arrow buttons to adjust the position of the enlarged picture.
Use the "▲" and "▼" arrow buttons to move the position up and down.
Use the "◀" and "▶" arrow buttons to move the position to the left and right.

NOTE:

- If the FREEZE button is pressed before the enlargement function is selected, the video impose function will not operate.
- If the MENU button is pressed, the display will return to the MENU screen, or the MENU screen will be cleared if it is already being displayed.
- If the FREEZE button is pressed while the enlargement function is operating, a still picture can be obtained. However, the input source cannot be switched and the MENU button will not operate until the FREEZE button is pressed once more to cancel the still picture.

□ Turning off the input signal display and the operable button guide display

The input signal display when the input source is switched, the operable button guide displays which appear on screens such as the POINT ZOOM screen and the VIDEO IMPOSE screen can be prevented from being displayed by turning off the on-screen display by the following procedure.

Setting procedure

1. Press the MENU button. ... The MENU screen will be displayed.
2. Use the “▲” and “▼” arrow buttons to move the cursor to “OPTION”.

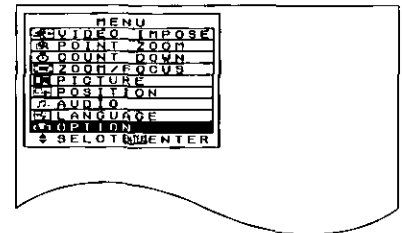

3. Press the ENTER button. ... The OPTION screen will be displayed.
4. Use the “▲” and “▼” arrow buttons to move the cursor to “INPUT DISP”.
5. Use the “◀” and “▶” arrow buttons to switch the setting to OFF.
 - If the setting is switched to ON, the input signal names and operable button guide displays will appear on the screen. (Factory default setting)

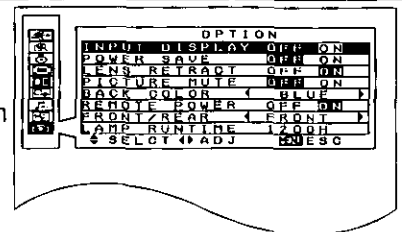

NOTE:

- If the MENU button is pressed, the display will return to the MENU screen, or the MENU screen will be cleared if it is already being displayed.

□ Disabling the POWER button of the remote control unit

The POWER button on the remote control unit can be disabled to prevent the chance of turning the power off by mistake when using the remote control unit. This setting can be made by following the procedure given below.

Setting procedure

1. Press the MENU button to display the MENU screen.
2. Press the “▲” and “▼” buttons to select “OPTION”.

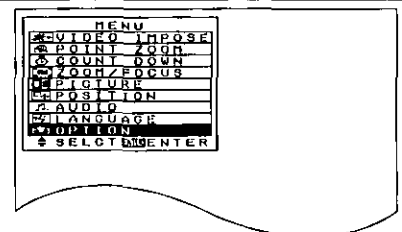

3. Press the ENTER button to display the OPTION screen.
4. Press the “▲” and “▼” buttons to select “REMOTE POWER”.
5. Press the “◀” and “▶” buttons to select “OFF”.
 - If this is set to “ON”, the POWER button on the remote control unit can be used to turn the power on and off. (Factory pre-setting)

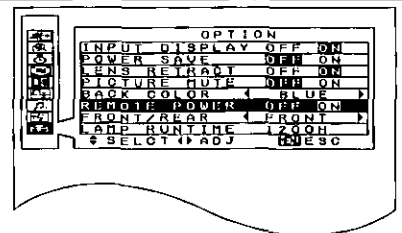

NOTE:

- If the MENU button is pressed, the display will return to the MENU screen, or the MENU screen will be cleared if it is already being displayed.

□ Changing the on-screen display language

When the projector is shipped from the factory, the on-screen display language is set to English. Data for five different languages is stored in the projector, so that you can select any one of these languages by following the procedure below.

Setting procedure <To change the language to German>

1. Press the MENU button. ... The MENU screen will be displayed.
2. Use the “▲” and “▼” arrow buttons to move the cursor to “LANGUAGE”.

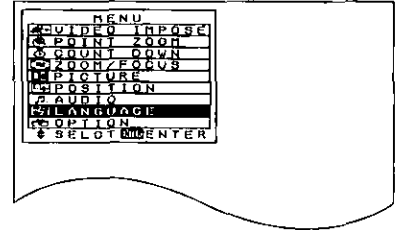

3. Press the ENTER button. ... The LANGUAGE screen will be displayed.
4. Use the “▲” and “▼” arrow buttons to move the cursor to “DEUTSCH”.
 - The languages available are English (ENGLISH), German (DEUTSCH), French (FRANÇAIS), Spanish (ESPAÑOL) and Japanese(日本語).

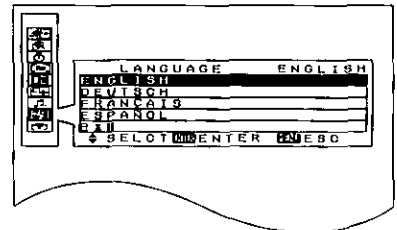

5. Press the ENTER button. ... The menus, setting and adjustment screens and the operable button guide displays will then appear in the language selected.

NOTE:

- If the MENU button is pressed, the setting screen or MENU screen will be cleared.
- The list of language selections in the LANGUAGE screen appear in the same way for all languages and does not change.

□ Using the countdown timer

The countdown timer can be used at times such as during breaks in meetings by displaying the amount of time remaining for something on the screen. The countdown time can be set to a maximum of 60 minutes, in units of 1 minute. The setting procedure is as follows.

Setting procedure

1. Press the MENU button to display the MENU screen.
2. Press the “▲” and “▼” buttons to select “COUNT DOWN”.

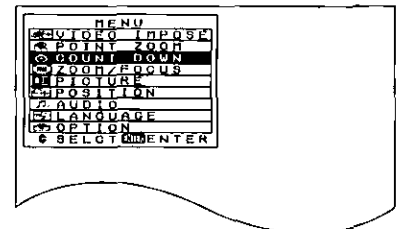

3. Press the ENTER button to display the COUNT DOWN screen.
4. Continue pressing the “◀” and “▶” buttons to set the time.
 - The setting can be made in units of one minute up to a maximum of 60 minutes.
 - This function can be disabled by setting the time to “0”.
5. Press the ENTER button. ... The countdown timer will then start.

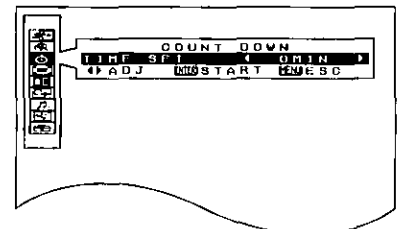

NOTE:

- During the countdown, the screen will appear in the background color as described on page 37.
- If the MENU button is pressed during the countdown, the timer display will be cleared and the screen will return to the COUNTDOWN setting screen.
- If the FREEZE button is pressed to produce a still picture and the countdown timer is then set or activated, the countdown will take place with the still picture still displayed.

□ Using the power save function

The power save function operates as follows: If the projector continues projecting for 10 minutes or more while there is no input signal to be projected, the light source lamp will shut off automatically to save power. After 20 minutes, the power supply will be turned off and the projector will enter standby mode. At the time of shipment from the factory, the power save function is set to OFF, so that if you would like to use this function, you can turn it on by the following procedure.

Setting procedure

1. Press the MENU button. ... The MENU screen will be displayed.
2. Use the “▲” and “▼” arrow buttons to move the cursor to “OPTION”.

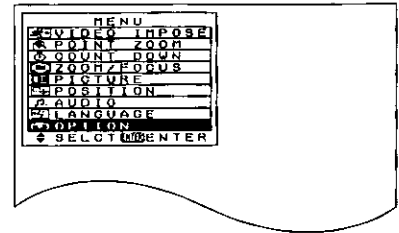

3. Press the ENTER button. ... The OPTION screen will be displayed.
4. Use the “▲” and “▼” arrow buttons to move the cursor to “POWER SAVE”.
5. Use the “◀” and “▶” arrow buttons to switch the setting to ON.

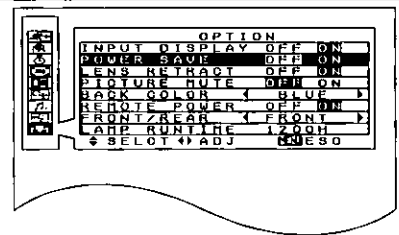

NOTE:

- If the light source lamp has turned off as a result of the power save function, the power indicator will appear orange. If a signal is then input, the power source lamp will switch back on and the picture will be projected. If the power supply has been turned off by this function, it can be turned back on by pressing the POWER button.
- If the MENU button is pressed, the display will return to the MENU screen, or the MENU screen will be cleared if it is already being displayed.
- If this function activates while the lens retract function is set to ON, you will need to re-adjust the lens according to the procedure on page 18.
- This function does not operate while the countdown timer is operating.

□ Using the lens retracting function

This function causes the projector lens to be retracted automatically when the projector switches to standby mode, and extends the lens again when the projector starts back up again. Having this function set to “ON” is useful if the projector will not be used for an extended period of time, or when the projector is to be transported somewhere. However, once the lens has been retracted, it will be necessary to readjust the zoom and focus of the lens once the projector has been started up again. At the time of shipment from the factory this function is set to “ON”.

Setting procedure

1. Press the MENU button to display the MENU screen.
2. Press the “▲” and “▼” buttons to select “OPTION”.

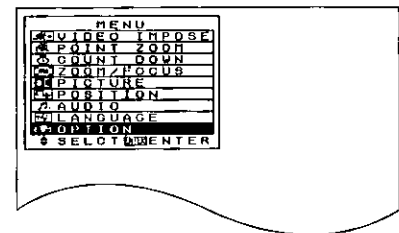

3. Press the ENTER button to display the OPTION screen.
4. Press the “▲” and “▼” buttons to select “LENS RETRACT”.
5. Press the “◀” and “▶” buttons to change the setting to “ON”.
 - If you set this function to “ON”, the lens will be extended and retracted each time the power is turned on and off.

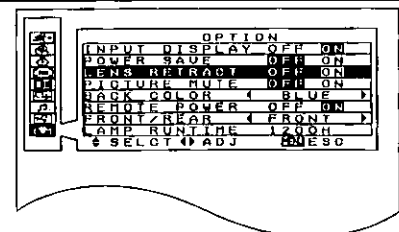

NOTE:

- If this function is set to “OFF”, the lens will remain extended at all times.
- If the MENU button is pressed, the display will return to the MENU screen, or the MENU screen will be cleared if it is already being displayed.

□ Setting the background color (screen color) when no signal is input or when the video signal is muted

The projector can be set to project either a solid blue image or a solid black image onto the screen if nothing is connected to the projector's input terminals, or if equipment is connected but no signal is being input from it. This setting is also effective when picture muting is active and when the countdown timer is running.

At the time of shipment from the factory, the color is set to "BLUE".

Setting procedure

1. Press the MENU button to display the MENU screen.
2. Press the "▲" and "▼" buttons to select "OPTION".

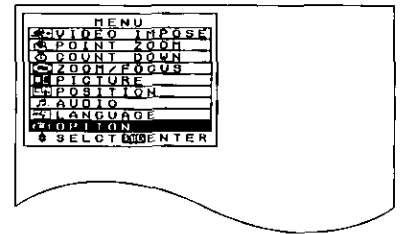

3. Press the ENTER button to display the OPTION screen.
4. Press the "▲" and "▼" buttons to select "BACK COLOR".
5. Press the "◀" and "▶" buttons to change the setting to "BLUE" or "BLACK".
 - This will set the color to be projected when no signal is being input.

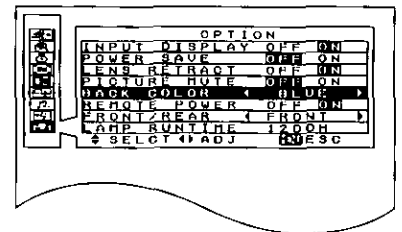

NOTE:

- If a signal that the projector cannot recognize is input, the projector will consider this to be no signal.
- If the MENU button is pressed, the display will return to the MENU screen, or the MENU screen will be cleared if it is already being displayed.

□ Using the MUTE remote control unit button to turn off both sound and picture

At the time of shipment from the factory, the MUTE button on the remote control unit is set so that only the sound is muted when the button is pressed. If you would like the picture to be muted along with the sound, set the PICTURE MUTE function to "ON" by the following procedure.

Setting procedure

1. Press the MENU button to display the MENU screen.
2. Press the "▲" and "▼" buttons to select "OPTION".

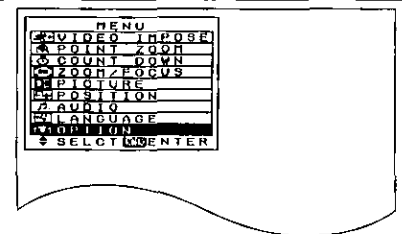

3. Press the ENTER button to display the OPTION screen.
4. Press the "▲" and "▼" buttons to select "PICTURE MUTE".
5. Press the "◀" and "▶" buttons to change the setting to "ON".
 - If the function is set to "ON", the picture will be muted along with the sound when the MUTE button is pressed.
 - If the function is set to "OFF", only the sound will be muted when the MUTE button is pressed. (Factory pre-setting)

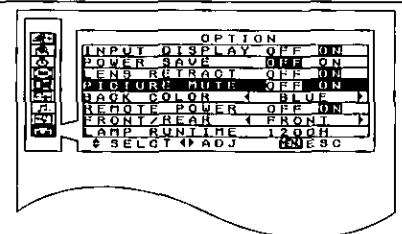

NOTE:

- Press the MENU button to clear the setting screen and the MENU screen.
- When PICTURE MUTE is on, the color projected will be the same color as the BACK COLOR setting.

System configuration example

Notes on system configuration

- Turn off the power supply of each system component before connecting any of the components.
- Read the instruction manual for each system component before connecting it.
- If the necessary cables for connecting any system components are not supplied with the component or available as an option, you may need to fashion a cable to suit the component concerned.
- If there is a lot of jitter in the video signal input from the video source, the picture on the screen may flicker. In such cases, it will be necessary to connect a TBC (time base corrector).
- The projector can be connected to video signal sources which output VIDEO, S-VIDEO and analog RGB signals (0.6–8.0 Vp-p synchronized signals).
- The projector has built-in speakers. However, you will need to connect a separate audio system to the AUDIO OUT terminal if your needs specify high sound volumes. No sound will come out of the projector's built-in speaker while the AUDIO OUT terminal is being used.
- It may not be possible to connect some types of computer.

Example of connection to audio-visual equipment

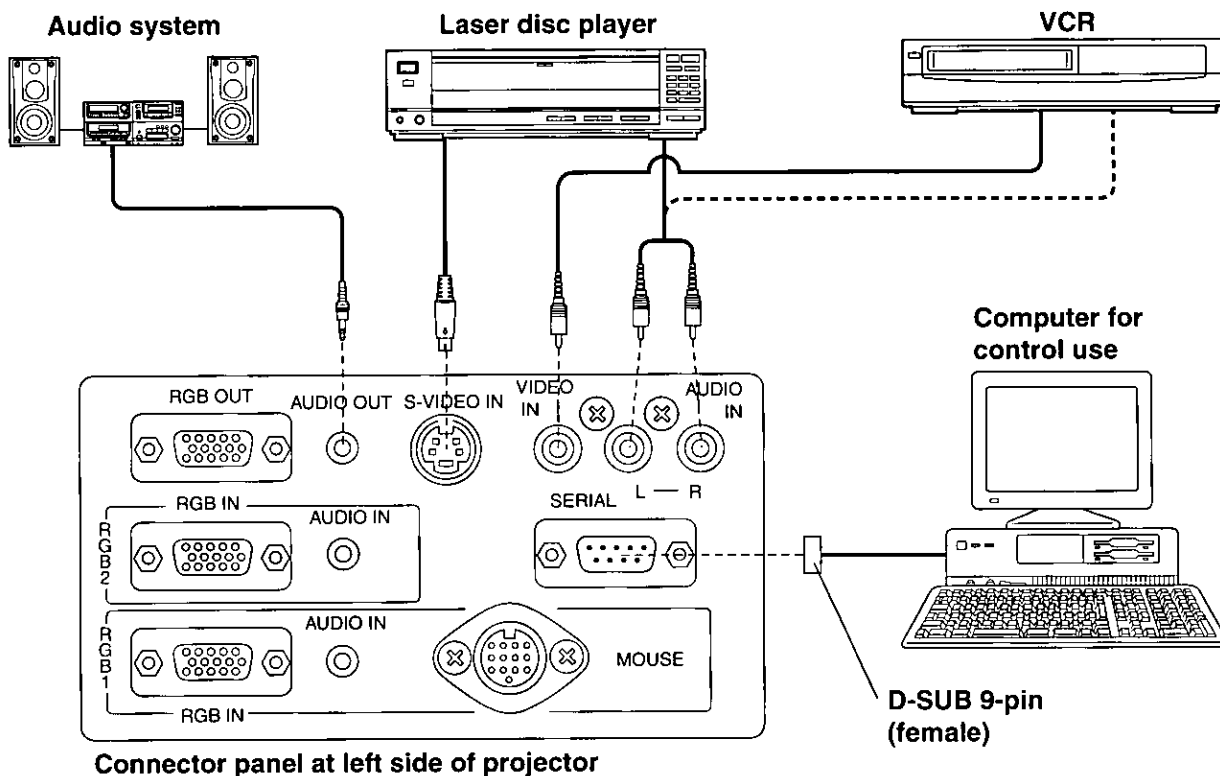

NOTE:

- If the S-VIDEO IN and VIDEO IN terminals are both connected at the same time, the S-VIDEO IN signal input will have priority. If you wish to view the signal being input to the VIDEO IN terminal, disconnect the plug from the S-VIDEO IN terminal.
- Only one audio signal input system is available for the AUDIO IN (L-R) terminals for S-VIDEO/VIDEO signals, so if you wish to change the audio input source, you will need to remove and insert the appropriate plugs.
- If the video signal source is connected using a cable with a BNC junction plug, use the BNC/RCA adapter to convert the pin jack.
- If an audio system is connected to the AUDIO OUT terminal, the sound volume balance and muting can be controlled by the remote control unit which is supplied with the projector. However, if the volume is set to "0", no audio signal will be output from the AUDIO OUT terminal.

Example of connection to a computer

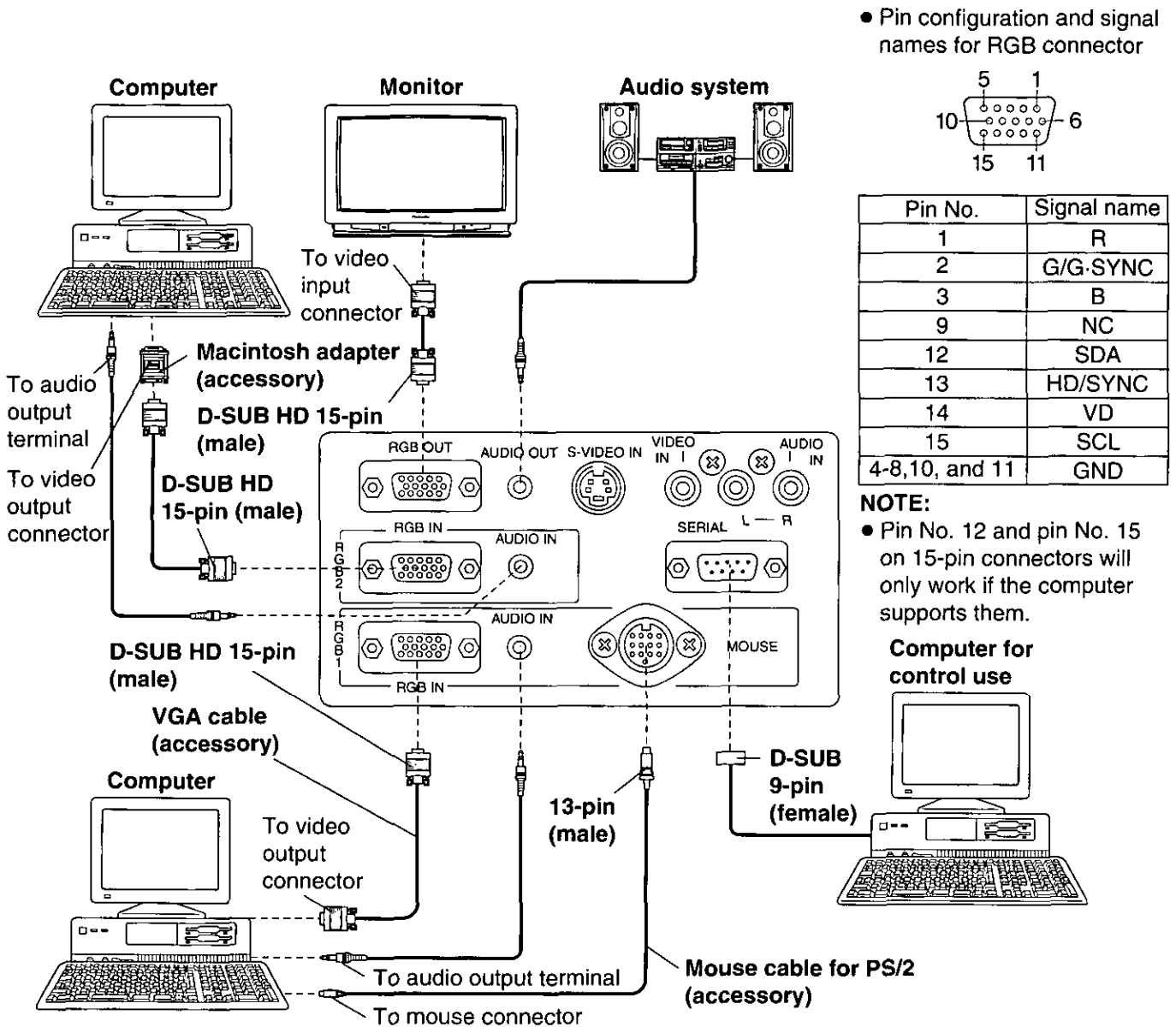

NOTE:

- If the mouse connector on the projector is connected to the mouse connector on the computer with the accessory or separate mouse cable, you can then use the remote control unit in place of the computer's mouse. However, this function operates only when input to the RGB 1 connector has been selected. For further details, refer to page 40.
- If you wish to use the infrared mouse function, turn on the main power to the projector before turning on the personal computer.
- If using a personal computer with a suspend/resume function, the infrared mouse function may not operate until the computer is restarted.
- Refer to the data on page 21 for the different types of RGB signal that can be input to this projector by connecting a personal computer.
- The signal output from the RGB OUT connector will be the signal which is input from the signal source which is connected to the RGB 1 or RGB 2 connector. However, no signal will be output if the RGB button has not been pressed to select RGB 1 or RGB 2, and when the projector power supply is turned off.

About the Macintosh adapter

An adapter for use with Macintosh computers is included with this unit. If image signals are to be input to this unit from a Macintosh computer, connect this adapter to the accessory VGA cable at the end which is to be connected to the computer. The resolution of the video signals output from the Macintosh computer can be switched by changing the adapter DIP switch settings.

Set the DIP switches to match the desired resolution according to the table given below.

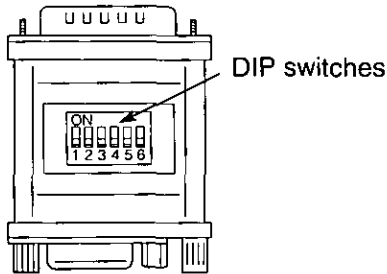

Display mode name/No. of dots	S1	S2	S3	S4	S5	S6
MAC 13 / 640 × 480	ON	OFF	OFF	OFF	ON	ON
MAC 16 / 832 × 624	OFF	ON	OFF	OFF	ON	ON
MAC 19 / 1024 × 768	OFF	OFF	ON	OFF	ON	ON
MAC 21 / 1152 × 870	ON	OFF	ON	OFF	ON	ON

Wireless mouse

A wireless mouse function is provided. This function lets you use the remote control unit to control a personal computer in place of the personal computer's mouse. This is done by connecting the projector to a personal computer using the mouse cable (6'7" (2.0 m)) which is supplied with the projector.

This projector is compatible with the following types of mouse only. Other types of mouse cannot be used.

- PS/2 mouse
- Macintosh mouse
- Serial mouse

Example of connection

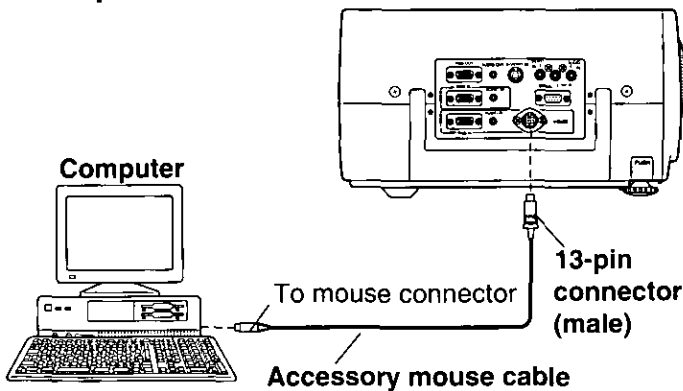

NOTE:

- Different mouse cables are used for different types of computers. Therefore, do not use any mouse cables other than the supplied mouse cables.
- The wireless mouse function operates only when input to the RGB 1 connector has been selected.

Operation

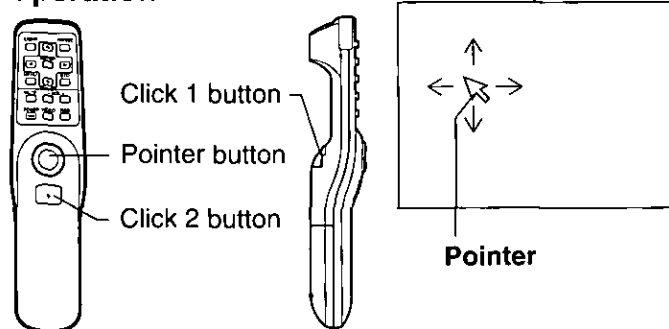

● Pointer button

While gently pressing the pointer button with your thumb, push the pointer button back and forward and to the left and right. The pointer (arrow) will move back and forward and to the left and right on the screen.

● Click 1 button

This button corresponds to the button on a single-button mouse, or to the left button on a standard mouse with two buttons.

● Click 2 button

This button corresponds to the right button on a standard mouse with two buttons.

Using the serial connector

The serial connector which is on the side terminal board of the projector conforms to the RS-232C interface specification, so that the projector can be controlled by a personal computer which is connected to this connector.

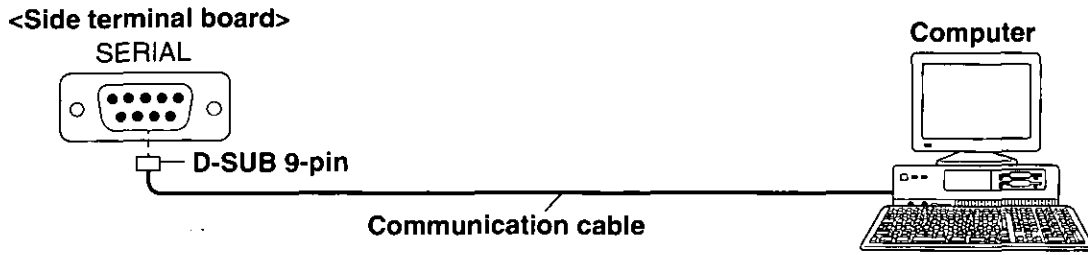

NOTE:

- Use a proper communication cable which is suitable for the personal computer to connect the serial connector and the personal computer.

Pin layout and signal names for SERIAL connector

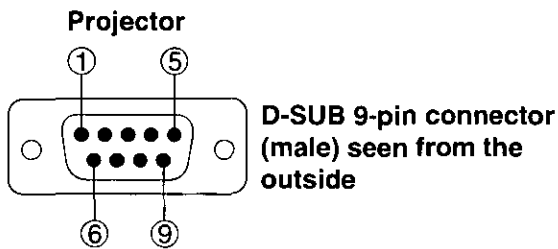

Pin No.	Signal name	Contents
①		NC
②	RXD	Received data
③	TXD	Transmitted data
④		NC
⑤	GND	GND
⑥		NC
⑦	RTS	Connected internally
⑧	CTS	
⑨		NC

Communication settings

Signal level	Determined by the RS-232C interface
Synchronizing method	Asynchronous
Baud rate	9600 bps
Parity	None
Character length	8 bits
Stop bit	1 bit
X parameter	None
S parameter	None

Basic format

Each packet which is sent from the computer starts with STX. Following this is the command itself and the parameters for that command (if any), and the packet then ends with ETX. Add parameters when necessary according to the control contents.

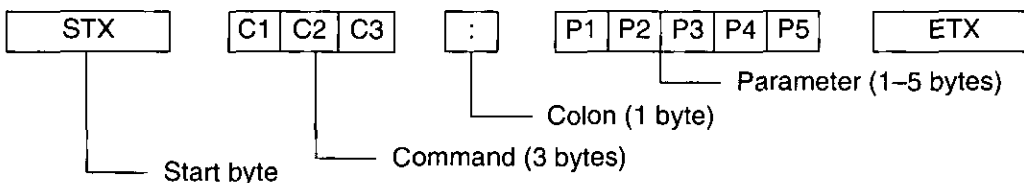

NOTE:

- If sending multiple commands, check that a response has been received from the projector for one command before sending the next command.
- If an incorrect command is sent from the personal computer, the "ER401" command will be sent from the projector to the personal computer.

Control commands

The commands which the personal computer can use to control the projector are shown in the following table.

Command	Control Contents	Remarks
PON	Power ON	In standby mode, all commands other than the PON command are ignored.
POF	Power OFF	
AVL	Volume	Parameter 000 = Adjustment value 0 : 063 = Adjustment value 63
AMT	Mute	Parameter 0 = MUTE OFF 1 = MUTE ON
IIS	Input signal selection	Parameter VID = VIDEO RG1 = RGB1 RG2 = RGB2

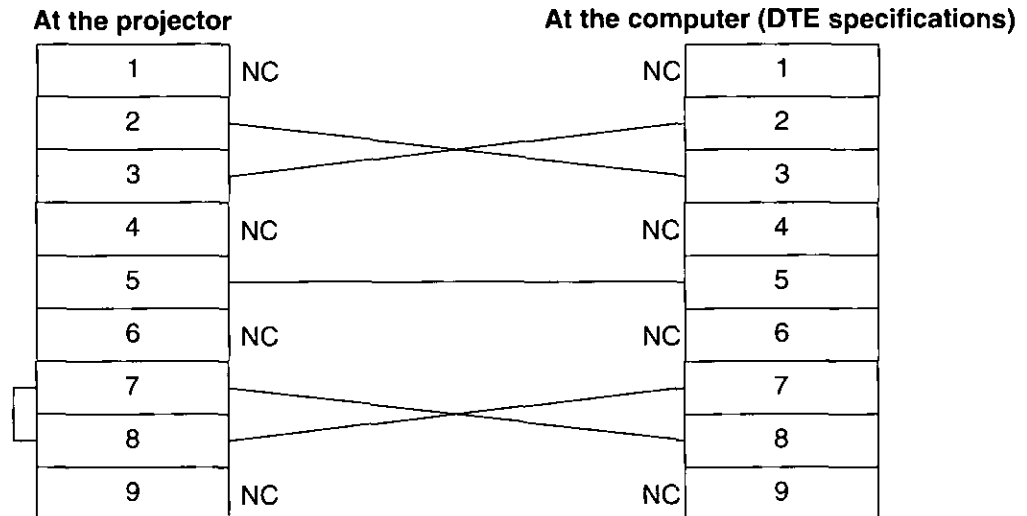

Cable specifications

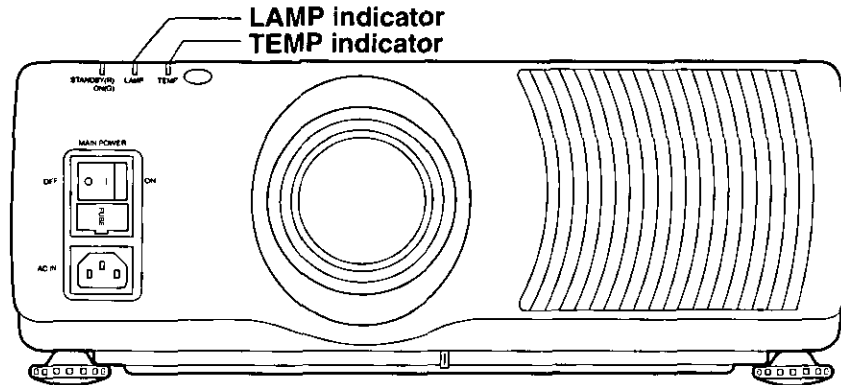

Indicators

There are two indicators on the front of the projector which give information about the operating condition of the projector. These indicators illuminate or flash to warn you about problems that have occurred inside the projector, so if you notice that one of the indicators is on, turn off the power and check the table below for the cause of the problem.



Indicator name	Indicator display	Problem	Possible cause	Remedy
TEMP indicator 	Illuminated (red)	The internal projector temperature is too high.	The ventilation holes may be covered. The ambient temperature in the place of use may be too high.	Uncover the ventilation holes. Set up the projector in a place where the temperature is between 41°F (5°C) and 104°F (40°C) and the humidity is between 10% and 80% (with no condensation).
	Flashing (red)	The metal halide lamp has turned off automatically because the internal temperature has risen to an abnormally high level.	The air filter may be blocked.	Turn off the main power supply by following the procedure on page 13, and then clean the air filter (refer to page 44).
LAMP indicator 	Illuminated (red)	It is nearly time to replace the lamp unit.	Does "LAMP" appear on the screen after the projector is turned on?	This occurs when the operation time for the lamp unit is nearing 1,800 hours. Ask your dealer or an Authorized Service Center to replace the lamp unit.
	Flashing (red)	The metal halide lamp switches off automatically.	The power may have been turned on immediately after it was turned off. There may be an abnormality in the lamp circuit.	Wait for a while until the lamp unit cools down before turning the power back on again. Turn off the main power supply by following the procedure on page 13, and then contact an Authorized Service Center.

NOTE:

- Be sure to turn off the main power by following the procedure given in "Turning the power on and off" on page 13 before carrying out any of the procedures in the "Remedy" column.
- If the main power turns off after the TEMP indicator starts flashing, it means that an abnormality has occurred. Please contact an Authorized Service Center so that the necessary repairs can be made.

Cleaning the air filter

If the air filter becomes clogged with dust, the internal temperature of the projector will rise, the TEMP indicator will flash and the projector will be switched automatically to standby mode.

Cleaning procedure

- 1. Turn off the main power supply and disconnect the power cord plug from the wall outlet.**
Turn off the main power supply according to the procedure given in "Turning off the power" on page 13 before disconnecting the plug from the wall outlet.

- 2. Place the projector on top of a blanket so that it will not become scratched.**

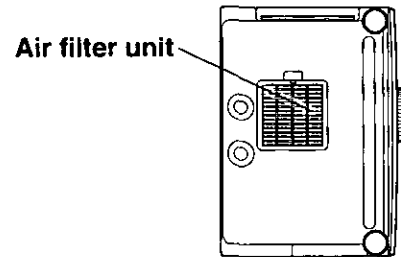

- 3. Remove the air filter cover.**
Hold the indents on the air filter cover with your hands and pull the air filter unit out of the projector.

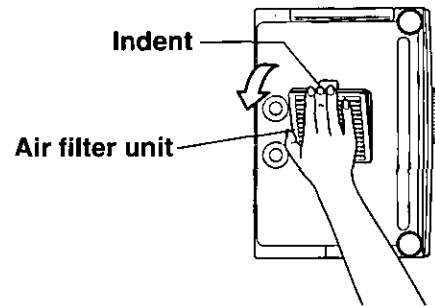

- 4. Remove the air filter clamp and then take out the air filter.**
Insert your finger into the indent in the air filter cover, bend the air filter clamp slightly inward, and then lift the air filter clamp upward to remove it.

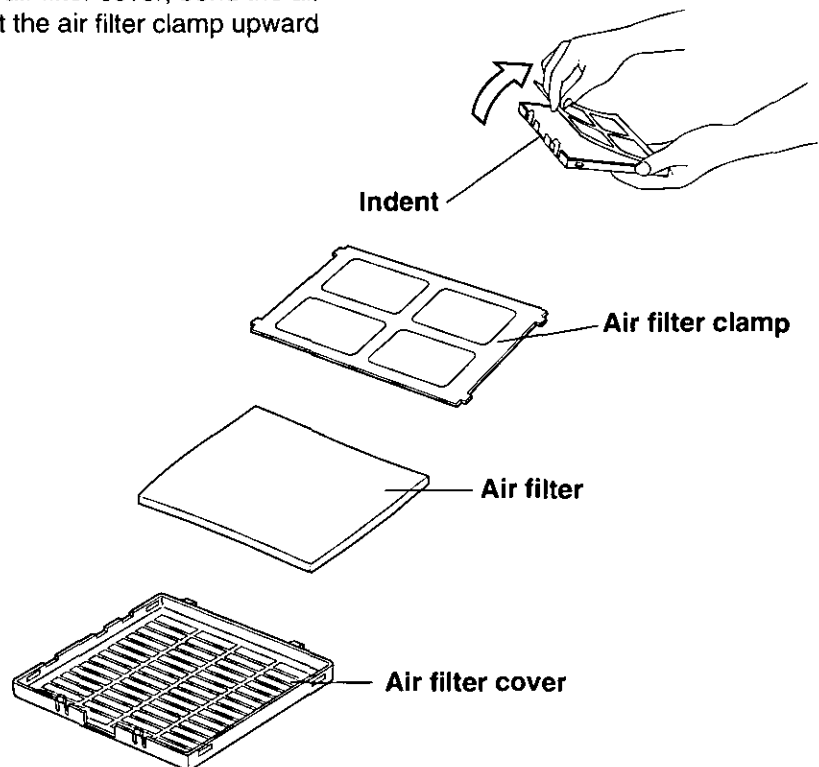

5. Clean the air filter and the air filter clamps.

Use a vacuum cleaner to clean off any accumulated dust.

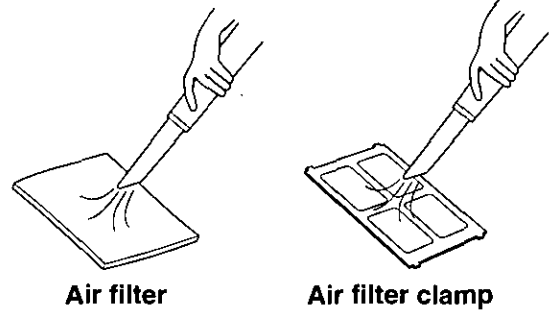

Air filter

Air filter clamp

6. Install the air filter and the air filter clamp to the air filter cover.

Place the air filter inside the air filter cover, and then insert the air filter clamp into its original position as shown in the illustration.

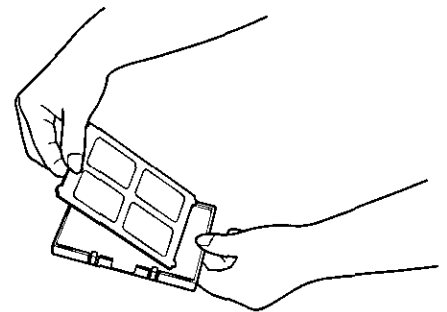

7. Install the air filter cover.

Slide the air filter cover into the projector until the hollows in the air filter cover are aligned with the hollows in the projector.

NOTE:

- Be sure to install the air filter cover before using the projector.
If the projector is used without the air filter cover installed, dust and other foreign particles will be drawn into the projector, and malfunctions will result.

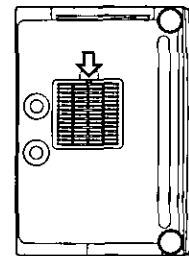

NOTE:

- If the dust cannot be removed by cleaning, it is time to replace the air filter. Please consult your dealer.

Lamp unit replacement period

The lamp used as the light source must be replaced after approximately 1,800 hours of use. If the lamp is not replaced after the cumulative usage time has passed 2,000 hours, the projector will automatically switch to standby mode.

- **Screen display once cumulative usage time exceeds 1,800 hours**

If you continue to use the lamp unit after 1,800 hours of total usage time have passed, the on-screen display shown at right will appear as a reminder each time the projector is turned on. This display will continue to appear until a button is pressed.

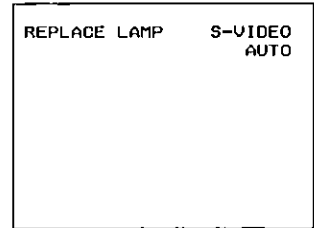

Replacing the lamp unit

Notes on replacing the lamp unit

- Because the lamp unit in this projector incorporates a metal halide lamp, the temperature inside the lamp rises during use and the lamp becomes very hot. After turning off the MAIN POWER switch and disconnecting the power cord from the wall socket, wait for the lamp to cool down before replacing the lamp unit.
- Take extreme care when handling the removed lamp unit, as it contains gas under high pressure and can easily become damaged if it is struck against hard objects or dropped.
- The old lamp unit may shatter if it is handled roughly after removal.
Ask an authorized waste disposal agency to dispose of the old lamp unit.
- A Phillips screwdriver is necessary for removing the lamp unit. Make sure that your hands are not slippery when using the screwdriver.

NOTE:

- The projector is not supplied with a replacement lamp unit. Please ask your dealer for details.
Lamp unit product no.: ET-LA095

CAUTION: Do not use any lamp unit other than the one with the product number indicated above.

□ Replacement procedure

NOTE:

- If the lamp unit is replaced after it has been used for more than 2,000 hours, the projector will switch to standby mode after approximately 10 minutes of operation. Steps 7. to 10. on the following page should thus be completed within 10 minutes.

1. Disconnect the power cord plug from the wall outlet and check that the area around the lamp unit has cooled down.

2. Use a Phillips screwdriver to remove the screw which is securing the lamp unit cover at the right side of the projector, and then remove the lamp unit cover.

NOTE:

- Read the CAUTION on the lamp unit cover before continuing.

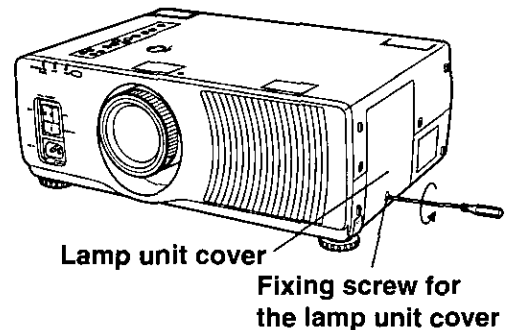

3. Turn the fixing screw for the lamp unit by hand until it turns freely.

CAUTION:

- The lamp unit will be hot after it has been used, and you might receive burns if you touch it while it is still hot.

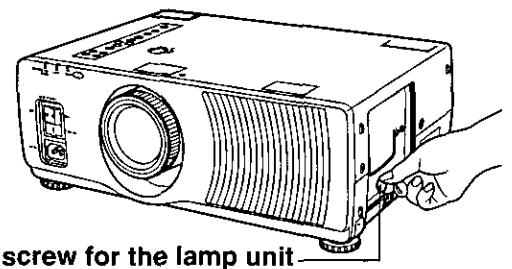

4. Hold the handle which is attached to the lamp unit and gently pull the lamp unit out from the projector.

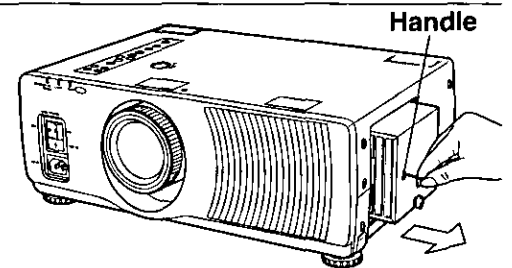

5. Insert the new lamp unit, while making sure that the direction of insertion is correct, and then turn the fixing screw for the lamp unit by hand until it is securely tightened.

NOTE:

- Insert the lamp unit so that the fixing screw for the lamp unit is facing downward.

6. Securely install the lamp unit cover, and then use a Phillips screwdriver to securely tighten the fixing screw for the lamp unit cover.

NOTE:

- Be sure to install the lamp unit and the lamp unit cover securely. If they are not securely installed, it may cause the protection circuit to operate so that the power cannot be turned on.

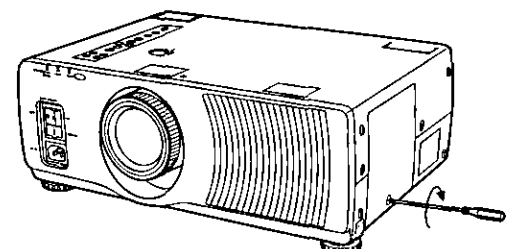

7. Insert the power cord plug into the wall outlet and then press the MAIN POWER switch on the front of the projector to turn on the power.

NOTE:

- If the power does not turn on when the MAIN POWER switch is pressed, turn the MAIN POWER switch off again and check that the lamp unit and the lamp unit cover are securely installed. Then turn the MAIN POWER switch back on.

8. Press the POWER button on the projector or remote control unit so that a picture is projected onto the screen.

9. -(1) Press the MENU button to display the MENU screen.
(2) Press the “▲” and “▼” buttons to select “OPTION”.

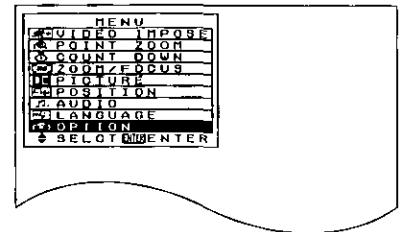

10.-(1) Press the ENTER button to display the OPTION screen.
(2) Press the “▲” and “▼” buttons to select “LAMP RUNTIME”.
• The cumulative usage time of the current lamp unit will be displayed on the screen.
(3) Press the “▶” button on the projector control panel continuously for three seconds or more. (The “LAMP RUNTIME” display will change to “TIME RESET”.)

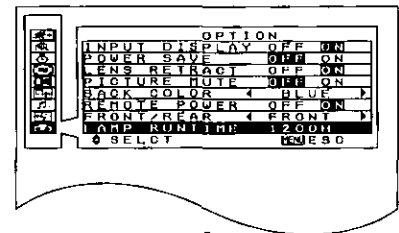

NOTE:

- The “▶” button on the remote control unit cannot be used at this time.

(4) While the OPTION screen (the screen showing “TIME RESET”) is being displayed, turn off the power. This will reset the cumulative usage time for the lamp unit.

NOTE:

- If any other buttons are pressed while “TIME RESET” is being displayed, the display will return to “LAMP RUNTIME” and the button pressed will take effect.

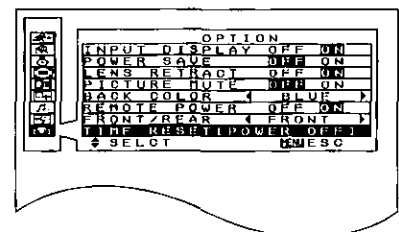

Before asking for service, check the following points.

Problem	Possible cause
Power does not turn on.	<ul style="list-style-type: none"> ● The power cord is not connected. ● The main power switch on the projector is turned off. ● The main power supply is not being supplied to the wall outlet. ● TEMP indicator is illuminated or flashing. Correct the problem while referring to the instructions on page 43. ● LAMP indicator is illuminated or flashing. Correct the problem while referring to the instructions on page 43. ● The lamp unit cover has not been correctly installed. ● The REMOTE POWER function has been set to "OFF". (Refer to page 34.)
No picture appears.	<ul style="list-style-type: none"> ● The lens cap may still be attached to the lens. ● The video signal input source may not be connected properly. ● The input selection setting may not be correct. (Refer to page 20.) ● The BRIGHT adjustment setting may be at the minimum possible setting. (Refer to page 25.) ● The PICTURE MUTE function has been set to "ON". (Refer to page 37.) ● The power save function has activated. (Refer to page 36.)
The picture is fuzzy.	<ul style="list-style-type: none"> ● The lens focus may not have been set correctly, or the projector may not be at the correct distance from the screen. (Refer to pages 15 and 18.) ● The lens may be dirty. ● The projector may not be set up so that it is perpendicular to the screen. (Refer to page 15.)
COLOR is too light or TINT is poor.	<ul style="list-style-type: none"> ● COLOR or TINT adjustment may be incorrect. (Refer to page 25.) ● The input source which is connected to the projector may not be adjusted correctly.
No sound can be heard.	<ul style="list-style-type: none"> ● The audio signal source may not be connected properly. ● The volume adjustment may be at the lowest possible setting. (Refer to pages 23 and 27.) ● The MUTE function may be active. (Refer to pages 24 and 37.)
Remote control unit does not operate.	<ul style="list-style-type: none"> ● The batteries may be spent, or they may not be inserted correctly. (Refer to page 9.) ● There may be an object between the remote control unit and the projector which is blocking the infrared signals. (Refer to page 10.) ● The remote control unit may be out of the operation range. (Refer to page 10.)
The picture does not display correctly.	<ul style="list-style-type: none"> ● The correct input signal may not be selected. (Refer to page 20.) ● The input signal setting mode (TV-SYSTEM) may not be set correctly. (Refer to page 22.) ● There may be a problem with the VCR tape or other signal source.

Specifications

Power supply:	100–120 V/220–240 V AC, 50/60 Hz
Power consumption:	430 W (During stand by (when fan is stopped): Approx. 7 W (at 100-120 V)/13 W(at 220-240 V))
Max amps:	4.5 A/2.5A
LCD panel:	
Panel size (diagonal):	1.3"
Display method:	3 transparent LCD panels (RGB)
Drive method:	Active matrix method
Pixels:	786,432(1024 × 768) × 3 panels
Lens:	Electronic zoom / focus lens (1:1–1.3) F 2.5–2.7, f 54–70 Retractable lens mechanism
Lamp:	Metal halide (280 W)
Luminosity:	650 lm/ANSI
Scanning frequency:	During S-VIDEO/VIDEO signal input H 15.75/15.63 kHz, V 50/60 Hz During RGB signal input Built-in data selection (point scan) method H 23–80 kHz, V 50–101 Hz (However, dot clock frequency is 135 MHz or less.)
Projection size (diagonal):	30–300 inches
Throw distance:	4'8"–52'2" (1.4–15.9 m)
Optical axis shift:	± 0/10
Screen aspect ratio:	4:3
Installation:	Front/Rear (Menu selection method)
Speaker:	1 ³ / ₁₆ " × 1 ¹ / ₈ " (4 cm × 2.85 cm) ellipse × 2 (stereo)
Max. usable volume output:	2W (1 W + 1 W) (10% THD)
Connection terminals:	
RGB IN:	Double-line D-SUB HD 15-pin (female)
R.G.B.:	0.7 Vp-p (1.0 Vp-p at G-SYNC signal) , 75 Ω
HD/SYNC:	0.6–8.0 Vp-p high impedance, automatic plus/minus polarity compatible
VD:	0.6–8.0 Vp-p high impedance, automatic plus/minus polarity compatible
RGB OUT:	Single-line D-SUB HD 15-pin (female)
R.G.B.:	0.7 Vp-p (1.0 Vp-p for G.SYNC signal), 75 Ω
HD/SYNC:	TTL high-impedance
VD:	TTL high-impedance
AUDIO IN:	Double-line 0.5 Vrms M3 jack (Stereo MINI)
S-VIDEO IN:	Single-line, Mini DIN 4-pin Y1.0 Vp-p,C 0.286Vp-p,75Ω,NTSC/NTSC 4.43/PAL/PAL-M/PAL-N /SECAM-compatible
VIDEO IN:	Single-line, RCA pin jack (S-VIDEO priority) 1.0 Vp-p, 75 Ω, NTSC/NTSC 4.43/PAL/PAL-M/PAL-N /SECAM-compatible
AUDIO IN L–R:	0.5 Vrms RCA pin jack × 2 (L–R)
AUDIO OUT terminal:	M3 jack (Stereo MINI) × 1 (monitoring output and stereo compatible)
SERIAL input connector:	0–2.0 Vrms (variable) D-SUB 9-pin (male) For computer-controlled operation

MOUSE input connector:	13-pin round connector For wireless mouse function (PS/2, Macintosh and serial computer compatible)
Power cord length:	9'6" (2.9 m)
Dimensions:	
Width:	16 ⁹ / ₁₆ " (421 mm)
Height:	6 ¹³ / ₃₂ " (163 mm)
Length:	11 ¹³ / ₁₆ " (300 mm) (not including lens extension length)
Weight:	22.1 lbs. (10.0 kg)
Operating environment:	
Temperature:	32°F–104°F (0–40°C)
Humidity:	20–80% (no condensation)
Certifications:	UL1950, C-UL FCC
<Remote control unit>	
Power supply:	3 V DC (two AA-size batteries)
Operation range:	23.0' (Approx. 7 m) (When operated from directly in front of the signal receptor)
Weight:	0.225 lbs. (Approx. 102g) (with batteries)
Dimensions:	
Width:	1 ¹³ / ₁₆ " (46 mm)
Height:	1 ¹¹ / ₃₂ " (34 mm)
Length:	7 ¹⁵ / ₃₂ " (190 mm)
Accessories	
Remote control unit (TNQE126):	1
AA-size batteries:	2
Power cord (TSXA053):	1 (125 V, 10 A)
VGA cable (TSXF122):	1 (6'7" [2.0 m], D-SUB HD 15-pin [male] ↔ D-SUB HD 15-pin [male])
Macintosh adapter (TJSF27000):	1 (D-SUB HD 15-pin [female] ↔ D-SUB 15-pin [male])
Video/Audio cable (TSXF015):	1 (4'11" [1.5 m], RCA pin)
PS/2 mouse cable (TSXF096):	1 (6'7" [2.0 m], 13-pin round [male] ↔ DIN 6-pin [male])
Macintosh mouse cable (TSXF105):	1 (6'7" [2.0 m], 13-pin round [male] ↔ mini DIN 4-pin [male])
Serial mouse cable (TSXF106):	1 (6'7" [2.0 m], 13-pin round [male] ↔ D-SUB 9-pin [male])
Optional accessories:	CEILING MOUNT BRACKET ET-PK592 ◆ Design and specifications are subject to change without notice. Weight and dimensions shown are approximate.

Trademark acknowledgements

- PS/2, VGA and XGA are trademarks of International Business Machines Corporation.
 - Macintosh is a registered trademark of Apple Computer, Inc.
 - PC-98 is a trademark of NEC Corporation.
 - S-VGA is a registered trademark of the Video Electronics Standards Association.
 - Windows is a registered trademark of Microsoft Corporation.
- All other trademarks are the property of the various trademark owners.

Dimensions

UNIT: inch (mm)

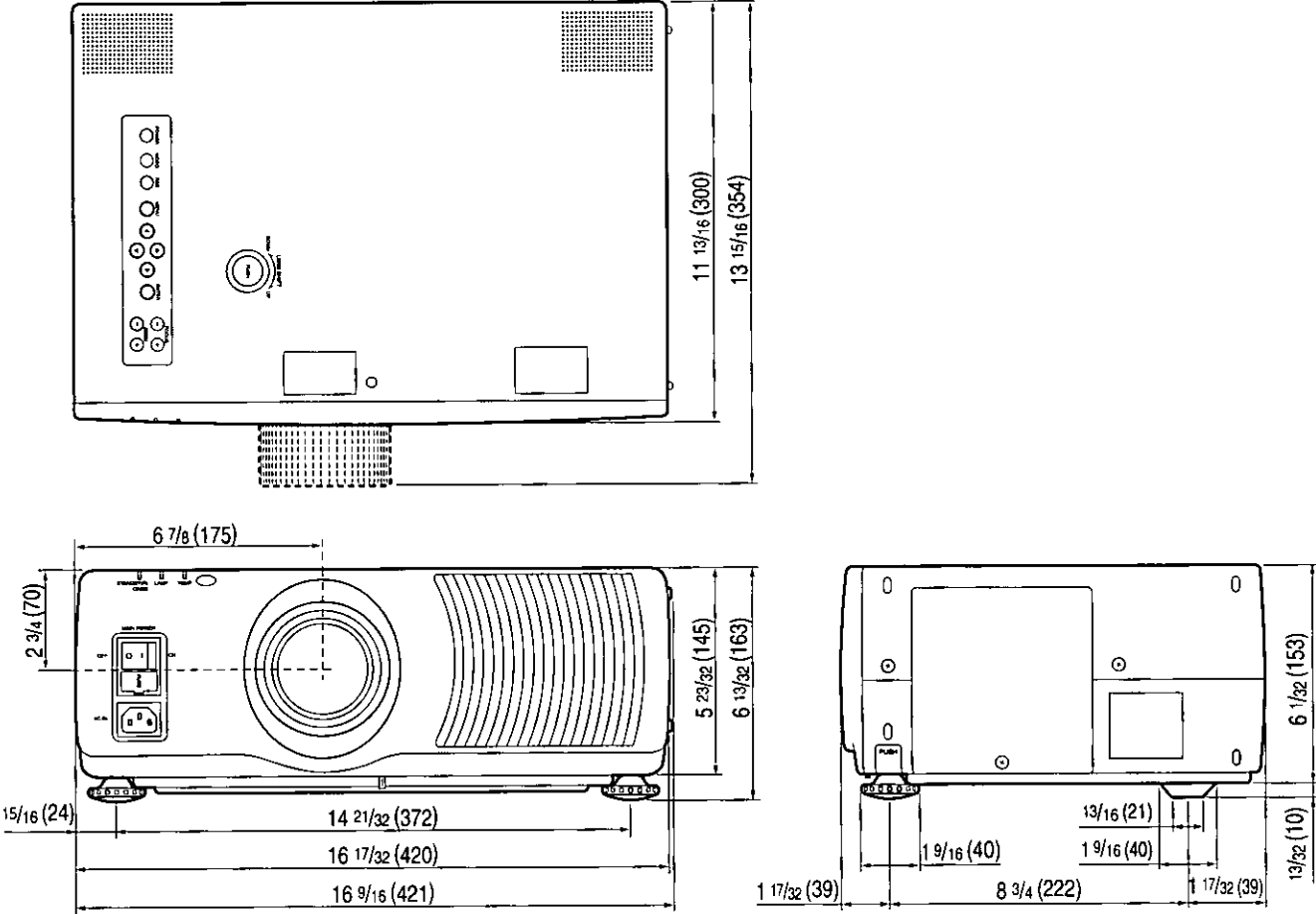

NOTES IMPORTANTES CONCERNANT LA SÉCURITÉ

AVERTISSEMENT: Afin d'éviter des dommages qui risquent de causer un incendie ou des chocs électriques, ne pas exposer cet appareil à la pluie ou à l'humidité.

Alimentation: Ce projecteur LCD a été conçu pour fonctionner seulement sur secteur domestique de 100–120 volts et 220–240 volts, 50/60 Hz.



Le symbole de la flèche en forme d'éclair, dans un triangle, avertit l'utilisateur de la présence de "tensions dangereuses" à l'intérieur du produit qui peuvent être de force suffisante pour constituer un risque de choc électrique aux personnes.



Le point d'exclamation dans un triangle avertit l'utilisateur de la présence d'instructions importantes concernant l'utilisation et l'entretien (réparation) dans la littérature accompagnant le produit.

ATTENTION: Cet appareil est équipé d'une fiche de courant à trois broches avec mise à la terre. Ne pas retirer la broche de mise à la masse de la fiche. Cette fiche ne pourra être utilisée que dans une prise avec mise à la terre. Ceci est une précaution sécuritaire. S'il est impossible d'insérer la fiche dans la prise, s'adresser à un électricien. Ne pas annuler la protection de la fiche à mise à la terre.

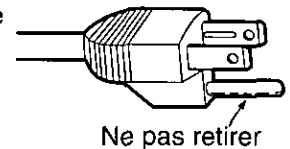

Précautions concernant la sécurité

AVERTISSEMENT

Installation

Ne pas installer ce projecteur dans un endroit qui n'est pas assez résistant pour supporter le poids du projecteur.

- Si l'emplacement d'installation n'est pas assez résistant, le projecteur risque de tomber et causer de graves blessures et (ou) des dommages.

Demander à un technicien qualifié d'installer le projecteur par exemple s'il est installé au plafond.

- Si l'installation n'est pas faite correctement, cela peut entraîner des blessures ou des chocs électriques.

Lors de l'utilisation du projecteur

Ne pas placer le projecteur sur des surfaces inclinées ou instables.

- Le projecteur risque de tomber ou de glisser.

Ne rien placer sur le projecteur.

- Si de l'eau se renverse sur le projecteur ou des objets entrent dans le projecteur, s'adresser à un centre de service autorisé.

Ne pas couvrir le filtre et la sortie d'air.

- Cela risque de faire surchauffer le projecteur, et causer un incendie ou endommager le projecteur.

Ne pas mettre d'objets étrangers dans le projecteur.

- Ne pas insérer d'objets métalliques ou inflammables dans les orifices de ventilation ou les faire tomber sur le projecteur, car cela peut causer un incendie ou des chocs électriques.

Ne pas retirer le couvercle ou le modifier.

- Des hautes tensions qui peuvent causer de graves blessures sont présentes à l'intérieur du projecteur. Pour toute inspection, réglage ou réparation, s'adresser à un centre de service autorisé.

Ne pas renverser d'eau sur le projecteur.

- Cela peut causer un incendie ou des chocs électriques.

Brancher la prise d'alimentation complètement.

- Si la fiche n'est pas complètement insérée, cela peut la faire surchauffer et causer un incendie. Si la fiche est endommagée ou la plaque de la prise est desserrée, elles ne devraient pas être utilisées.

Ne pas manipuler le cordon d'alimentation avec les mains mouillées.

- Cela peut entraîner des chocs électriques.

Faire attention de ne pas endommager le cordon d'alimentation.

- Ne pas endommager le cordon d'alimentation, ne pas le modifier, ne pas placer d'objets lourds, ne pas le chauffer, ne pas le placer près d'objets chauffants, ne pas le tordre, ne pas le plier ou le tirer excessivement. Cela peut entraîner un incendie et des chocs électriques. Si le cordon d'alimentation est endommagé, le faire réparer par un centre de service autorisé.

Nettoyer le cordon d'alimentation régulièrement afin d'éviter toute accumulation de poussière.

- Si de la poussière s'accumule sur le cordon d'alimentation, l'humidité peut endommager l'isolant et entraîner un incendie. Débrancher le cordon d'alimentation de la prise de courant et l'essuyer avec un chiffon sec.
- Si le projecteur ne sera pas utilisé pendant une période prolongée, débrancher le cordon d'alimentation de la prise de courant.

En cas de problème pendant l'utilisation

En cas de problème (pas d'image ou de son), ou si le projecteur dégage de la fumée ou une odeur étrange débrancher immédiatement la fiche d'alimentation de la prise de courant.

- Si l'on continue d'utiliser le projecteur dans cette condition, cela peut entraîner un incendie ou des chocs électriques. Après s'être assuré que de la fumée ne se dégage plus, s'adresser à un centre de service autorisé et demander que les réparations nécessaires soient faites. Le fait de réparer le projecteur soi-même est très dangereux, et ne doit jamais être fait.

Si de l'eau ou des objets étrangers entrent dans le projecteur, si le projecteur tombe, ou si le boîtier est endommagé, débrancher immédiatement la fiche d'alimentation de la prise de courant.

- Un court-circuit peut se produire et causer un incendie. S'adresser à un centre de service autorisé pour que les réparations nécessaires puissent être faites.

PRÉCAUTION

Lors de l'utilisation du projecteur

Ne pas utiliser le projecteur là où il sera sujet à l'humidité, la poussière, la vapeur d'huile ou de la vapeur.

- Cela peut causer des chocs électriques.

Ne pas placer d'objets lourds sur le projecteur.

- Cela peut déséquilibrer le projecteur et le faire tomber, ce qui peut entraîner des dommages et/ou des blessures.

Ne pas regarder directement dans la lentille pendant que le projecteur fonctionne.

- Une lumière intense est émise par la lentille du projecteur. Si l'on regarde directement dans cette lumière, elle risque de causer de graves blessures aux yeux.

Ne pas placer ses mains ou autres objets près de la sortie d'air.

- De l'air chaud sort par l'ouverture de sortie d'air. Ne pas placer les mains ou la figure, ou d'autres objets qui ne peuvent résister à la chaleur près de cette sortie d'air, sinon cela peut causer des blessures ou une déformation.

Lors du débranchement du cordon d'alimentation, tenir la fiche, et non pas le cordon.

- Si l'on tire sur le cordon, cela risque de l'endommager entraînant la possibilité d'un incendie ou de chocs électriques graves.

S'assurer de débrancher tous les câbles avant de déplacer le projecteur.

- Si le projecteur est déplacé avec des câbles encore branchés, cela peut les endommager et entraîner un incendie ou des chocs électriques.

Nettoyage et entretien

Faire attention lors du remplacement de l'unité de lampe.

- La lampe au métal-halide contient du gaz sous haute pression. Si elle tombe ou si elle est cognée, elle risque de se casser, ce qui peut causer des blessures ou des problèmes de fonctionnement.

Demander à un centre de service autorisé de nettoyer l'intérieur du projecteur au moins une fois par an.

- S'il n'est pas nettoyé et que la poussière s'accumule à l'intérieur du projecteur, cela peut causer un incendie ou des problèmes de fonctionnement. Se renseigner auprès du centre de service autorisé pour le coût du nettoyage.

Avant de nettoyer le projecteur, débrancher le cordon d'alimentation.

- Sinon, cela peut causer des chocs électriques.

Avertissement pour l'utilisation d'une alimentation de 220–240 V

Lorsqu'on utilise ce projecteur avec une alimentation de 220–240 V, il faut remplacer le cordon d'alimentation et le fusible. Utiliser un cordon d'alimentation et un fusible correspondant aux spécifications indiquées ci-contre à droite. Sinon, on risquera de provoquer un incendie ou des anomalies.

Cordon d'alimentation	250 V CA, 10 A
Fusible	250 V CA, T4 A, diam. 5,2 mm, longueur 20 mm

Remplacer le fusible conformément à la procédure suivante.

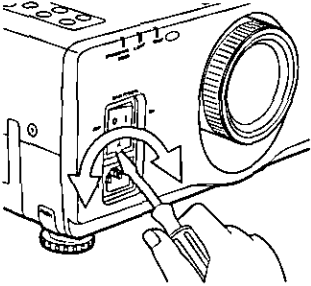
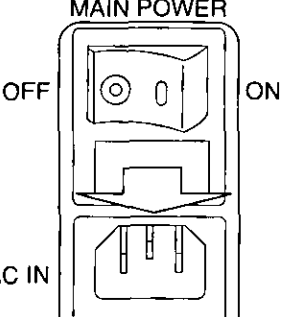
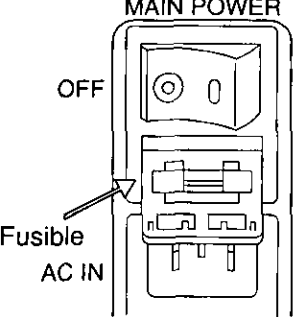
<p>① Introduire un tournevis à tête plate et étroite dans l'orifice situé sous le support de fusible, et tourner le tournevis de deux ou trois tours vers la gauche et la droite.</p> 	<p>② Après avoir déplacé le support de fusible légèrement vers l'avant, le tirer vers soi.</p> 	<p>③ Remplacer le fusible par un fusible de 250 V CA, T4 A, puis remettre le support de fusible bien à sa place.</p> 
---	--	--

Précautions à suivre lors de la manipulation

Avertissements concernant l'installation

Respecter les points suivants en tout temps lors de l'installation du projecteur.

- Éviter l'installation dans des endroits sujets à vibrations ou chocs.
Si le projecteur est installé dans des endroits sujets à vibrations, comme près d'un moteur, ou s'il est installé à l'intérieur d'un véhicule ou sur un bateau, le projecteur peut être soumis à des vibrations ou chocs qui peuvent endommager les composantes internes et causer un mauvais fonctionnement ou des accidents. Installer donc le projecteur dans un endroit qui n'est pas sujet à vibrations ou chocs.
- Ne pas installer le projecteur près de lignes à haute-tension ou près de moteurs.
Le projecteur peut être affecté par des interférences électromagnétiques s'il est installé près de lignes à haute-tension ou près de moteurs.
- Ne pas installer le projecteur directement sur une feuille en plastique ou sur un tapis.
La feuille de plastique peut coller au filtre à air, ce qui peut causer une surchauffe interne du projecteur et déclencher la coupure de l'alimentation.
- Si le projecteur est installé au plafond, demander à un technicien qualifié de faire l'installation.
Si le projecteur doit être installé au plafond, il faudra se procurer un ensemble d'installation vendu séparément (Modèle ET-PK592). De plus, l'installation au complet doit être réalisée par un technicien qualifié.

Remarques concernant l'utilisation

- Afin d'obtenir la meilleure qualité possible d'image
Si la lumière du jour ou la lumière de lampes d'éclairage éclaire l'écran, les images projetées n'auront pas le contraste adéquat. Fermer les rideaux des fenêtres, éteindre les éclairages fluorescents près de l'écran et couvrir tout plancher ou mur à haute réflexion de tapis ou papier peint pour éviter la réflexion.
- Ne pas toucher la surface de lentille avec les mains nues.
Ne pas toucher à la lentille avec les mains nues. Si la surface de la lentille porte des traces de doigts ou autre, elles seront projetées sur l'écran. De plus, ne pas oublier de rétracter la lentille et la couvrir avec le protecteur fourni lorsque le projecteur n'est pas utilisé.
- À propos de l'écran
Si l'écran utilisé est sale, endommagé ou décoloré, de belles images ne peuvent pas être obtenues. Ne pas appliquer de produit chimique volatil sur l'écran et ne pas le laisser se salir ou s'endommager.

Avant de faire toute opération de nettoyage ou entretien, s'assurer de débrancher la fiche du cordon d'alimentation de la prise de courant.

Essuyer le boîtier avec un chiffon doux, sec.

Si le boîtier est très sale, tremper le chiffon dans de l'eau avec une petite quantité de détergent neutre, bien essorer le chiffon, puis essuyer le boîtier. Après le nettoyage, sécher le boîtier avec un chiffon doux, sec. Lors de l'utilisation d'un chiffon traité chimiquement, lire les instructions accompagnant le chiffon avant l'utilisation.

Ne pas essuyer la lentille avec un chiffon poussiéreux ou qui produit de la peluche.

Si de la poussière ou de la peluche se dépose sur la lentille, cette poussière ou peluche sera grossie et projetée sur l'écran.

Utiliser un aspirateur pour retirer toute poussière ou peluche sur les surfaces des lentilles, ou utiliser une peau de chamois pour nettoyer la poussière ou la peluche.

À propos de la condensation

Des gouttelettes d'eau se forment sur les fenêtres chauffées rapidement en hiver, et sur l'extérieur de bouteilles sorties du réfrigérateur en été.

Ce phénomène s'appelle la condensation; si de la condensation se produit sur les surfaces de la lentille de projection ou sur le miroir à l'intérieur du projecteur, l'image sera floue ou risque même de ne pas être visible.

Si l'humidité est élevée, ou si le projecteur est déplacé rapidement d'un endroit froid à un endroit chaud, la projection sera arrêtée automatiquement. Dans ce cas, la projection reprendra lorsque le projecteur atteint la température ambiante.

Période de remplacement de la lampe

La lampe utilisée comme source de lumière doit être remplacée après environ 1800 heures d'utilisation. Si la lampe n'est pas remplacée après que l'utilisation totale atteigne 2000 heures, le projecteur passera automatiquement en mode d'attente.

- **Affichage à l'écran lorsque l'utilisation totale dépasse 1800 heures**

Si l'on continue d'utiliser l'unité de lampe après 1800 heures d'utilisation totale, l'affichage à l'écran indiqué à droite apparaîtra à chaque fois que le projecteur est allumé. Cet affichage restera affiché jusqu'à ce qu'une touche soit pressée.



REPLACER LAMPE S-VIDEO
AUTO

Remplacement de l'unité de lampe

Remarques concernant le remplacement de l'unité de lampe

- Étant donné que l'unité de lampe de ce projecteur utilise une ampoule au métal-halide, la température interne de la lampe augmente pendant l'utilisation et la lampe devient très chaude. Après avoir mis l'interrupteur MAIN POWER sur OFF et avoir débranché le cordon d'alimentation de la prise de courant, attendre que la lampe se refroidisse avant de remplacer l'unité de lampe.
- Faire très attention lors de la manipulation de l'unité de lampe retirée, car elle contient un gaz sous haute pression et peut facilement être endommagée si cognée contre des objets durs ou si elle tombe.
- L'unité de lampe retirée peut exploser si manipulée rudement après le retrait.
Demander à une agence de mise au rebut agréée de s'occuper de mettre au rebut l'unité de lampe retirée.
- Un tournevis Phillips sera nécessaire lors du retrait de l'unité de lampe. S'assurer que ses mains ne glissent pas lors de l'utilisation du tournevis.

REMARQUE:

- Une unité de lampe de remplacement n'est pas fournie avec le projecteur. Pour plus de détails, s'adresser au revendeur.
Numéro de pièce de l'unité de lampe: ET-LA095

ATTENTION: Ne pas utiliser une unité de lampe avec un numéro de pièce autre que celui indiqué ci-dessus.

□ Remplacement de l'unité de lampe

REMARQUE:

- Si l'unité de lampe est remplacée après une durée d'utilisation de plus de 2000 heures, le projecteur passera en mode d'attente après environ 10 minutes d'utilisation. Dès lors, faire les étapes 7. à 10. à la page suivante dans les 10 minutes.

1. Débrancher le cordon d'alimentation de la prise de courant et s'assurer que les pièces autour de l'unité de lampe se sont refroidies.

2. Utiliser un tournevis Phillips pour retirer la vis qui fixe le couvercle de l'unité de lampe sur le côté droit du projecteur, puis retirer le couvercle de lampe.

REMARQUE:

- Avant de continuer, lire l'étiquette sur l'unité de lampe.

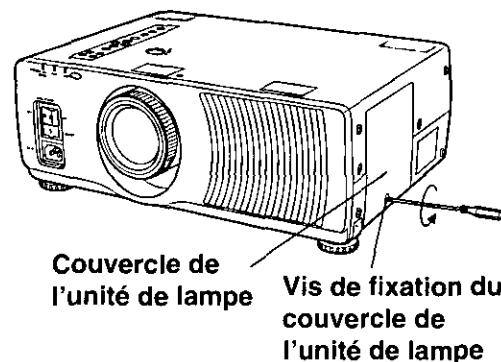

3. Tourner à la main la vis de fixation de l'unité de lampe, jusqu'à ce qu'elle tourne librement.

PRÉCAUTION:

- L'unité de lampe sera chaude après l'utilisation et l'on risque de se brûler si on la touche lorsqu'elle est encore chaude.

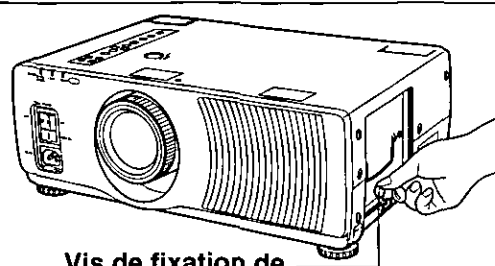

Vis de fixation de l'unité de lampe

4. Tenir la poignée qui est attachée à l'unité de lampe et tirer doucement pour sortir l'unité de lampe du projecteur.

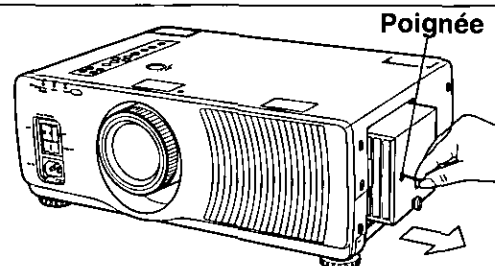

Poignée

5. Insérer la nouvelle unité de lampe, en s'assurant que la direction d'insertion est correcte, puis tourner à la main la vis de fixation de l'unité de lampe jusqu'à ce qu'elle soit correctement fixée.

REMARQUE:

- Insérer l'unité de lampe de sorte que le vis de fixation de l'unité de lampe soit situé en bas.

6. Installer le couvercle de l'unité de lampe, puis serrer les vis de fixation à l'aide du tournevis Phillips.

REMARQUE:

- S'assurer que l'unité de lampe et le couvercle sont correctement installés. S'ils ne sont pas correctement installés le circuit de protection risque de se déclencher et le projecteur ne pourra pas être allumé.

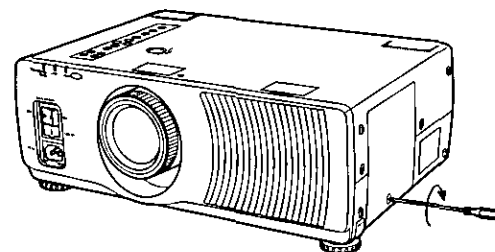

7. Brancher la fiche du cordon d'alimentation dans la prise de courant et appuyer sur l'interrupteur MAIN POWER sur l'avant du projecteur pour l'allumer.

REMARQUE:

- Si le projecteur ne s'allume pas lorsque l'on appuie sur l'interrupteur MAIN POWER, mettre l'interrupteur sur OFF de nouveau et vérifier que l'unité de lampe et le couvercle sont correctement installés. Mettre l'interrupteur MAIN POWER sur ON de nouveau.

8. Appuyer sur la touche POWER sur le projecteur ou la télécommande pour projeter une image sur l'écran.

9. -(1) Appuyer sur la touche MENU pour afficher le MENU.
(2) Appuyer sur les touches "▲" et "▼" pour sélectionner "OPTION".

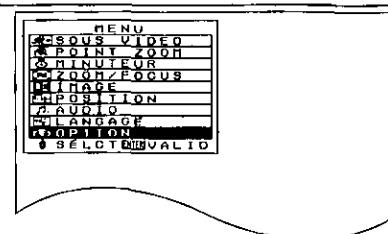

- 10.-(1) Appuyer sur les touche ENTER pour afficher l'écran "OPTION".
 (2) Appuyer sur les touches "▲" et "▼" pour sélectionner "DURÉE LAMPE".
 • La durée d'utilisation totale de l'ancienne unité de lampe sera affichée à l'écran.
 (3) Appuyer sur la touche "▶" sur le panneau de commande du projecteur pendant 3 secondes ou plus. (Le message "DURÉE LAMPE" sera remplacé par le message "INIT COMPT".)

REMARQUE:

- La touche "▶" sur la télécommande ne peuvent pas être utilisées pour cette opération.

- (4) Pendant que le menu "OPTION" (le message "INIT COMPT") est affiché, couper l'alimentation. Cela remettra à zéro la durée d'utilisation totale.

REMARQUE:

- Si d'autres touches sont pressées pendant que le message "REMISE TEMPS" est affiché, l'affichage indiquera "DURÉE LAMPE" et la touche pressée sera exécutée.

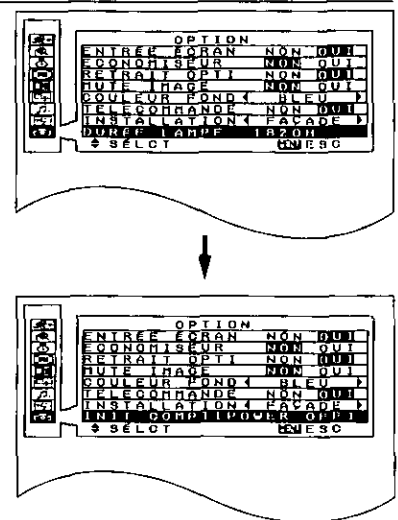

Panasonic[®]

Professional/Industrial Video

Panasonic Broadcast & Television Systems Company
 Division of Matsushita Electric Corporation of America

Executive Office:

One Panasonic Way (2E-6) Secaucus, New Jersey 07094

EASTERN ZONE:

610 (269) 8369

CENTRAL ZONE:

608 (846) 4778

WESTERN ZONE:

707 (584) 7189

Government Marketing Department: 52 West Gude Drive, Rockville, MD 20850 (301) 738-3840

Panasonic Canada Inc.

5770 Ambler Drive, Mississauga, Ontario L4W 2T3 (905) 624-5010